



Fortus® 900mc 3D Production System

User Guide

Part No. 108314-0009, Rev. A

Liability Statement

The information in this document is subject to change without notice. Stratasys, Inc. shall not be liable for errors contained herein or for incidental or consequential damages in connection with the furnishing, performance, or use of this material.

Stratasys, Inc. makes no warranty of any kind with regard to this material, including, but not limited to, the implied warranties of merchantability and fitness for a particular purpose. It is the responsibility of the system owner/material buyer to determine that the Stratasys material is safe, lawful, and technically suitable for the intended application as well as identify the proper disposal (or recycling) method consistent with local environmental regulations. Except as provided in Stratasys' standard conditions of sale, Stratasys shall not be responsible for any loss resulting from any use of its products described herein.

Copyright Statement

This document is protected by copyright. All rights reserved. Its use, disclosure, and possession are restricted by an agreement with Stratasys per software copyright. No part of this document may be photocopied, reproduced or translated into another language without the prior written consent of Stratasys, Inc.

All drawings and information herein are the property of Stratasys Inc. All unauthorized use and reproduction is prohibited.

Trademark Acknowledgments

Insight is a trademark of Stratasys, Inc.

Stratasys, FDM, and Fortus are registered trademarks of Stratasys, Inc.

Fortus 900mc, Fortus 360mc and Fortus 400mc are trademarks of Stratasys Inc. in the United States and other countries.

Windows NT, Windows 2000, and Windows XP are registered trademarks of Microsoft Corporation.

Krytox and Teflon are registered trademarks of DuPont.

Ultem* 9085 is a trademark of SABIC Innovative Plastics IP BV.

All other product names are the property of their respective owners.

Stratasys Incorporated

7665 Commerce Way
Eden Prairie, MN 55344-2080
USA
952.937.3000
Fax: 952.937.0070
www.stratasys.com

© Copyright 2014 Stratasys Inc. All rights reserved.
Printed in the United States of America.

Table of Contents

Chapter 1: Service and Support	1-1
Service and Software Support	1-1
In the USA	1-1
In Europe	1-1
Consumable Orders	1-2
Safety Instructions	1-2
Hazard Types	1-2
Specific Safety Practices	1-3
Oven	1-3
Guard Door Interlocks	1-3
General Safety Practices	1-3
Chapter 2: System Components	2-1
Access Doors and Panels	2-1
Top Slide Covers	2-2
Oven Door	2-2
Canister Bay Door	2-2
Power In Disconnect Switch	2-2
Signal Tower	2-3
Emergency Stop	2-3
Touchscreen	2-3
Power On	2-4
Power Off	2-4
Back of System	2-4
Onboard Computer	2-4
UPS	2-5
System Top	2-6
Opening the Top Slide Covers	2-6
Gantry Assembly	2-6
Head Assembly	2-7
Head Maintenance Bracket	2-7
Model Materials and Tips	2-9
Materials	2-9
Materials Used	2-9
Materials Compatibility	2-10
Liquefier Tips	2-11
Liquefier Tips and Slice Heights	2-11
Tip Compatibility and Selection	2-11
Tip Identification	2-15
Oven	2-16
Oven Door	2-16
Oven Components	2-17

Oven Lamps _____	2-17
Platen _____	2-18
Purge Bucket _____	2-19
Canister Bay _____	2-19
Accessing the Bays _____	2-19
Canister Bay Components _____	2-20
SmartSpool System _____	2-21
Chapter 3: Setup and Installation _____	3-1
General Information _____	3-1
Prepare Your Facility for Installation _____	3-1
Identifying Your System _____	3-1
Basic Setup _____	3-2
Making the Network Connection _____	3-2
Air Supply Connection _____	3-2
Making the Power Cable Connection _____	3-2
Network Setup _____	3-3
Configuring the Network _____	3-3
Setting the IP Address _____	3-4
Chapter 4: Operating the System _____	4-1
Basic User Interface and Operations _____	4-1
Using the Touchscreen _____	4-2
Touchscreen Buttons _____	4-3
Touchscreen Icons _____	4-3
Touchscreen Symbols _____	4-7
Materials/Tools Display _____	4-10
Canister State _____	4-10
Queue Window _____	4-11
Sensor Status _____	4-12
System Status _____	4-13
System Defaults _____	4-13
System Log _____	4-14
Technician Menu _____	4-14
Tip Offset Menu _____	4-15
Part Placement Menu _____	4-15
Administrator Menu _____	4-16
System Default Values _____	4-17
Display Units _____	4-17
User Placement _____	4-17
Auto Cool Oven _____	4-17
Enable Security _____	4-17
Building Screen _____	4-18
Platen Vacuum _____	4-18
Health Monitor _____	4-19
Alert Types _____	4-20

Monitored Values _____	4-20
Touchscreen Navigation _____	4-21
Building Screen _____	4-21
Materials/Tools _____	4-22
Calibration Menu _____	4-23
Adjust XYZ Calibration Offsets _____	4-24
Tips/Materials Change _____	4-25
Technician _____	4-26
Administrator _____	4-27
System Default _____	4-28
Log Off _____	4-29
Queue Window _____	4-30
Move Commands _____	4-31
Powering On the System _____	4-32
Powering Off the System _____	4-32
Basic Job Build Tasks _____	4-33
Before a Job Build _____	4-33
Select a Job to Build _____	4-34
Build Job Warnings _____	4-36
Information Available During a Build _____	4-38
Pausing or Stopping a Job _____	4-39
After a Job Build _____	4-40
Removing Supports _____	4-41
Breakaway Support Material _____	4-41
Soluble Release Support Material _____	4-41
Support Material for PPSF Parts _____	4-41
Material, Canisters, and Liquefier Tips _____	4-43
Unloading Material from the Liquefier Tips _____	4-43
Removing Canisters _____	4-44
Canister Installation _____	4-45
Loading Material to the Liquefier Tips _____	4-48
Canister Auto Changeover _____	4-49
Handling/Storing Canisters _____	4-49
Changing Tips or Material Type _____	4-50
Working with the Job Queues _____	4-53
System Status _____	4-54
Chapter 5: Calibration _____	5-1
Automatic Calibration _____	5-1
Start Auto Z Zero Calibration _____	5-2
Start Auto Tip Calibration _____	5-2
Adjust XYZ Calibration Offsets _____	5-3
AutoHome XYZ _____	5-6
Chapter 6: System Maintenance _____	6-1
Updating Controller Software _____	6-1

Web Method (preferred method) _____	6-1
CD Method (alternate method) _____	6-2
Placing System in Receive Software Upgrade Mode _____	6-3
Reinstalling Controller Software (Using USB Flash Drive) _____	6-4
Maintenance Schedule _____	6-5
Daily Maintenance _____	6-6
Clean the Platen _____	6-6
Empty the Purge Bucket _____	6-7
Weekly Maintenance _____	6-8
Vacuum the Build Envelope _____	6-8
Clean/Inspect Tip Wipe Assembly _____	6-8
Quarterly Maintenance _____	6-10
Clean the Tip Sensor Plunger _____	6-10
As Needed Maintenance _____	6-11
Clean The Liquefier Tips _____	6-11
Replace an Oven Lamp _____	6-11
Cleaning the Cabinet _____	6-11
Cleaning Plastic Components _____	6-12
Chapter 7: Troubleshooting _____	7-1
Getting Help _____	7-1
In the USA _____	7-1
In Europe _____	7-1
Finding a Remedy _____	7-2

Revision Log

FORTUS 900mc User Guide

Revision	Date	Description of Changes
A	August 2008	First release of this document.
B	June 2009	Updated materials and miscellaneous screen shots and text. Changed system name.
C	October 2010	Updated cubic inches and cubic centimeters for T16 and T20 life on Ultem * 9085 model material. Removed "FDM 900mc" in all cases and added Fortus as a registered trademark. Updated UPS illustration. Updated Tip/Materials Change Wizard illustration. Updated material build temperatures and updated minor corrections throughout the guide.
D	November 2011	Added ABS-ESD7 new material that has static dissipative properties to the Use Guide. Added new support material and updated Liability Statement, Copyright Statement and Trademark Acknowledgments. Added Appendix B WaterWorks to this User Guide.
E	September 2012	Updated Formatting and added Controller Software updates.
F	July 2013	Added section on updating Controller software. Changed dash number from -0003 to -0006 to match revision level.
G	November 2013	Added Nylon 12 material option information throughout. Removed Appendix A and B. The information within these appendices will be converted into a materials/support best practices reference document available at a later date.
108314-0008_REV_A *part numbering convention change from previous releases	July 2014	Added ASA material option information throughout. Made various minor corrections throughout.
108314-0009_REV_A	November 2014	Added Ultem 1010 material option, including T14 model tip, information throughout.

Safety

The following basic safety s are given to ensure safe installation, operation, and maintenance of Stratasys equipment and are not to be considered as comprehensive on matters of safety. The Fortus 900mc systems are designed to be safe and reliable rapid prototyping system. Access to areas of the system are potentially dangerous.

Safe Environment

- Connect equipment to a grounded facility power source. Do not defeat or bypass the ground lead.
- Know the location of equipment branch circuit interrupters or circuit breakers and how to turn them on and off in case of emergency.
- Know the location of fire extinguishers and how to use them. Use only ABC type extinguishers on electrical fires.
- Know local procedures for first aid and emergency assistance at the customer facility.
- Use adequate lighting at the equipment.
- Maintain the recommended range of temperature and humidity in equipment area.
- Do not use this product in an environment containing volatile or flammable compounds.

Safe Human Interface

- Use proper lifting techniques when moving or installing the equipment.
- Use standard electrostatic discharge (ESD) precautions when working on or near electrical circuits.
- Do not defeat or disconnect safety interlocks.

Hazard Classifications

Be aware of the following hazard classification used in this manual.



Caution: Indicates a potentially hazardous situation that may result in minor or moderate injury.



Warning: Indicates a potentially hazardous situation that may result in death or serious injury.



Always read and adhere to safety statements, and be aware of the following safety signs located on the system.

Product Safety Signs

We make every effort to ensure that our systems are safe and reliable at all times. However, there will be times when you must access areas of the system where potentially high voltages, hot temperatures, and/or moving mechanical components could cause severe injury.



Always read and adhere to safety statements, and be aware of the following safety signs when you see them on the system.



Personal Injury Sign. The personal injury sign indicates mechanical parts, and severe personal injury is possible. Always use extra care. Do not wear ties, loose clothing, or dangling jewelry. Keep long hair tied up and away from any moving parts.



High Voltage Sign. The high voltage sign indicates the presence of high voltages. Always stay away from any exposed electrical circuitry. It is recommended that all jewelry be removed.



Hot Surface Sign. The hot surface sign indicates the presence of devices with high temperatures. Always use extra care when working around heated components. Always wear the safety gloves and safety sleeves provided in the Fortus 900mc Startup Kit.



Gloves & Sleeves-Required Sign. The gloves sign indicates that safety gloves and sleeves approved for high temperatures must be used. These are provided in the Startup Kit.



Sharp-Object Sign. The sharp object sign indicates the presence of sharp objects. Do not touch sharp objects as they may cause a loss of body parts.



Crushed-Hand Sign. The crushed hand sign indicates that a crushing hazard exists between two objects.



Do Not Enter Oven Sign. This sign warns you to never enter the oven with your entire body.



Use standard electrostatic discharge (ESD) precautions when working on or near electrical circuits.

The following components and areas of the system are highlighted as potential safety hazards that may cause system failure or reliability problems if proper safety procedures are not followed.

Oven



Always wear safety gloves and long sleeves when working inside the oven. Components are hot! The oven temperature is extremely hot. The oven heater is controlled by a safety thermal breaker that shuts the system off the temperature reaches 300° C (572° F). Opening the oven door shuts the oven heaters off.

XY Gantry



Never wear a tie, loose clothing or dangling jewelry when working around moving components of the system. Beneath the top cover of the system is the XY Gantry. This area houses the mechanical drive components of the X and Y axes. Use extreme caution whenever accessing this area of the system. The servo drive system is extremely powerful so care must be taken. The servo motors are disabled when the oven door or top covers are opened. The XY pinch hazard between the timing belts and pulleys is minimized by locking the hood while building and disabling the motors when the top hood is open.

Z Stage



Never wear a tie, loose clothing or dangling jewelry when working around moving components of the system. The Z-Stage and Z-Stage servo motor can cause severe injury. The Z-Stage crushing hazard is minimized by locking the door during Z-Stage movement and disables the Z-Motor when the door is open.

Guard Door Interlocks

Interlock switches are used to communicate the status of the oven door and the top covers to the system. For safety reasons, the oven door and top covers must be closed before the X, Y, and Z motors will operate.

General Safety Practices

Use the following safety practices when working with this system.



Warning: High voltage is present in the system when powered off and unplugged due to the uninterruptible power supply (ups).



Warning: Only use an OSHA or CE approved step stool when accessing the gantry area under the top covers (located at the top of the system).



Warning: Always wear safety gloves and long sleeves when working in the oven, with the head, or liquefier s. these components can get very hot.

Removing Electrical Power

Any time service is being performed on the Fortus 900mc AC power must be removed to the system. Perform the system shutdown sequence on the system before removing power to the system.

Make sure the main breakers at the facility site are in their OFF position before preceding to remove any electrical panels.

 **Warning:** Make sure AC power is removed from the system. Voltage of 230VAC is present and can be lethal.

Any time service is being performed on the Fortus 900mc system, especially the electrical panel where high voltage power is present, the incoming power should be locked out to prevent someone else from inadvertently energizing the electrical system.

When line voltage is removed from the system, a UPS (Uninterruptible Power Supply) is designed to provide power to some components in the of the system. Make sure to manually turn off the UPS when servicing the system.

 **Warning:** Make sure the UPS is manually turned off and not powering components in the system.

Procedure

1. Shut down the system and turn Off the power.
2. Rotate the power in disconnect switch counterclockwise to the Off position.

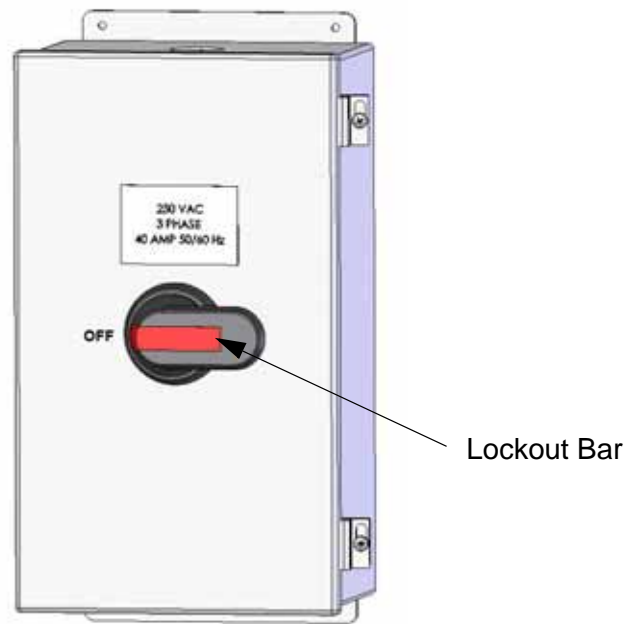

Figure 1: Power In Disconnect Switch

3. Flip the lockout bar to the locked position. Note that the circuit breakers cannot be returned to the ON position when the lockout bar is in the locked position.
4. Secure the lockout bar with an external lock. The lockout bar will not stay in the locked position without an external lock.
 - Each person servicing the system should have a personal lock.
 - Never remove someone else's lock from the lockout.

About the Fortus 900mc

Welcome to the Fortus 900mc®. This systems incorporate the latest in innovative technologies that produce accurate and functional parts. Stratasys' Fused Deposition Modeling® (FDM) technology provides prototype parts, including internal features, that can be used to field-test form, fit, and function.

Components of the Fortus 900mc

- Insight™ Software Package
- A generic computer workstation (not sold by Stratasys)
- The Fortus 900mc System
- Modeling Material
- Support Material

System

- The vacuum platen is adapted for use with two build sheet sizes. The small sheet is 16 in. (40.6 cm) X 18.5 in. (47.0 cm) X 0.02 in. (0.05 cm) thick. The large sheet is 26 in. (66.0 cm) X 38 in. (96.5 cm) X 0.02 in. (0.05 cm) thick.
- Envelope Size: 36 in. (91.4 cm) wide X 36 in. high (91.4 cm) X 24 in. (60.96 cm) deep.
- Material Bays: 2 model, 2 support
- Slice Heights:
 - T12/0.007 inch (0.178 mm)
 - T14/0.010 inch (0.254 mm)
 - T16/0.010 inch (0.254 mm)
 - T20/0.013 inch (0.330 mm)



Material choice affects available size/slice height.

About This Guide

This guide is your introduction to building parts using a Fortus 3D Production System. It is designed as a learning and reference tool that explains system operation in an easy to understand, step-by-step process.

How to Use This Guide

This guide is divided into easy-to-follow chapters. The tabs allow you to quickly and easily find the information you want. You can read this user guide chapter by chapter or use the tabs, and Table of Contents you need to quickly find specific information. Keeping this user guide close to your system will efficiently allow you to troubleshoot and maintain the system.

Conventions Used in This Guide

The following conventions are used in this guide.

- If you see text in **bold** it indicates that this is a key located on the Operator Touchscreen. If you see boxed blue text, it indicates that this information is being shown on the Operator Panel Screen.
- Icons that are grayed out on the Operator Touchscreen are not active.



Chapter 1: Service and Support



This chapter provides the user with information on service and support for the Fortus 900mc system.

Service and Software Support

If you have a problem with your Fortus 900mc that is not covered in this User Guide, please contact Stratasys Customer Support.

When calling in for service, always have your system's software version (see ["System Status" on page 4-54](#)), and hardware serial number available (see ["Identifying Your System" on page 3-1](#)). You may also need access to your Insight workstation to provide a diagnostic file from your hardware.

In the USA

- Write to:
Stratasys, Inc.
Customer Support
7665 Commerce Way
Eden Prairie, MN 55344-2080
USA
- Phone: 800.801.6491 (7:00 AM to 5:00 PM C.T.)
- Email: support@stratasys.com

In Europe

Please contact your local distributor. For information on your local distributor please contact our European head quarters:

- Write to:
Stratasys GmbH
Weismuellerstr. 27
60314 Frankfurt/Main
Germany
- Phone: +49 (69) 420 994 30
- Fax: +49 (69) 420 994 333
- E-mail: europe@stratasys.com

Consumable Orders

If you need to order consumables for your Fortus hardware, contact your distributor or reseller.

When ordering consumables, always have your system's serial number and software version number available.

Safety Instructions

Hazard Types

Stratasys recommends that all services be performed by qualified personnel. All personnel working on or around this system should be knowledgeable of what the following hazard classifications mean throughout this guide.



Warning: Indicates a potentially hazardous situation which, if not avoided, may result in injury or death.



Caution: Indicates a situation which, if not avoided, could result in damage to equipment.

WARNINGS and CAUTIONS precede the paragraph to which they pertain.

Specific Safety Practices

The following components and areas of the system are highlighted as potential safety hazards that may cause system failure or reliability problems if proper safety procedures are not followed.

Oven



Warning: Always wear safety gloves and long sleeves when working inside the oven. Components are hot!

Warning: The oven temperature is extremely hot. The oven temperature is controlled by a safety thermal breaker that shuts the system off when temperatures reach 260° C (500° F)



Opening the oven door removes power to the oven heaters

Guard Door Interlocks

Interlock switches are used to communicate the status of the oven door and the two top slide covers. For safety reasons, the oven door and the slide covers must be closed before the X, Y, and Z motors will operate.

General Safety Practices

Abide by these general safety practices when working with this system.



Warning: High voltage is present in the system when powered off and unplugged because of the Uninterruptible Power supply (UPS).

Warning: Only use an OSHA or CE approved step stool when accessing the area under the top slide covers (located at the top of the system).

Warning: Always wear safety gloves and long sleeves when working in the oven, with the head, or liquefier tips. These components are very hot.



Chapter 2: System Components

2

This chapter describes the system components of the Fortus 900mc system. Information on model materials and tips that can be used by the system are also included in this chapter.

Access Doors and Panels



Warning: The access doors should only be removed by an authorized Stratasys service technician.

This system has been designed to allow easy access to the most frequently accessed areas on the system. The doors and top slide covers are highlighted in [Figure 2-1](#).

Figure 2-1: Top Slide Covers and Doors

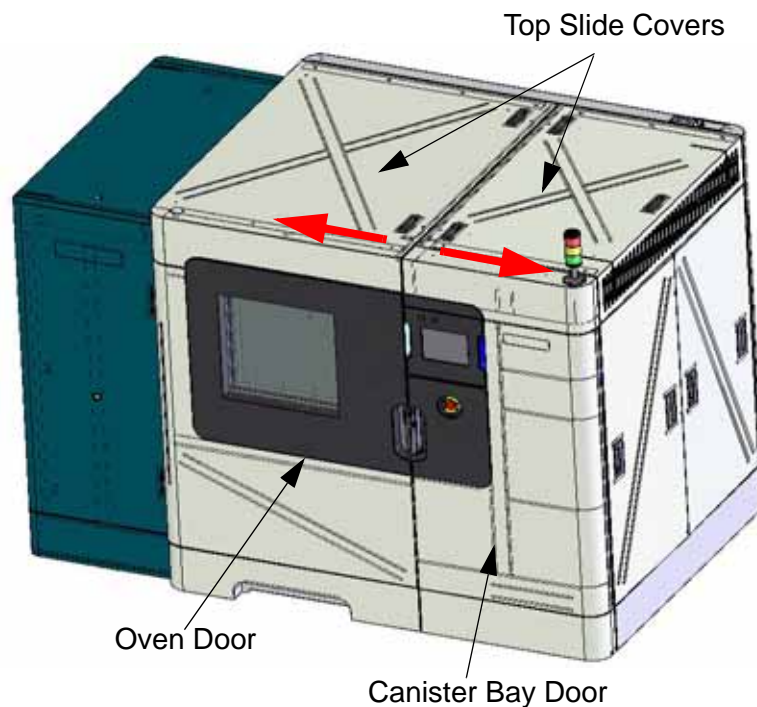

Top Slide Covers

Allows access to the head, gantry area, and access for changing model and support tips on the head. The cooling fans are located in this area to provide airflow through the upper portion of the system.



Warning: Only use an OSHA or CE approved step stool when accessing the area under the top slide covers.

Oven Door

Allows access to the platen, tip wipe assemblies, purge bucket, and completed parts.



Warning: always wear safety gloves and long sleeves when working in the oven, with the head, or liquefier tips. these components are very hot.

Canister Bay Door

Allows access to the four canister bays, canister levers, and canister LEDs.

Power In Disconnect Switch

The Power In Disconnect switch, located at the back of the system, acts as the main circuit breaker. Rotating this switch to OFF will remove AC power to the system. There is a Lockout Bar that can be used to lock the switch in the off position.



Warning: High voltage is present in the system when powered off and unplugged because of the Uninterruptible Power supply (UPS).

Figure 2-2: Power In Disconnect Switch

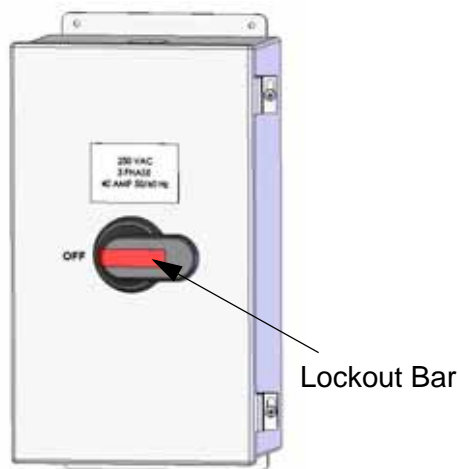
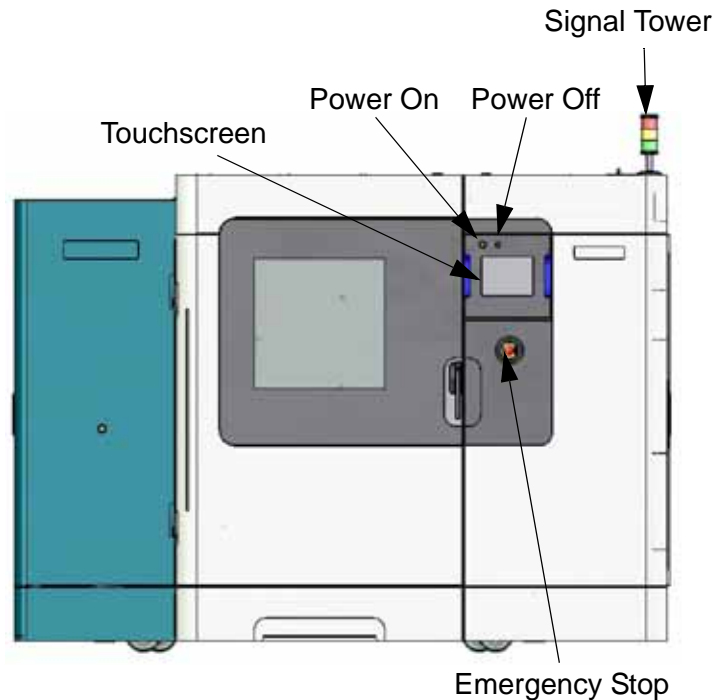

Figure 2-3: Fortus 900mc Front View



Signal Tower

Visually displays the status of the Fortus 900mc. (Figure 2-3)

Green: System is OK; it is building a part, or it is finished building a part.

Yellow: All monitored parameters are within tolerance. (See “Health Monitor” on page 4-19 for details.)

Red: An indicator has moved beyond its control limit and is now outside of its specification limit. The system will not allow a part to start building. The system may pause, or stop, or power down depending on the condition.

Emergency Stop

Pressing the Emergency Stop button immediately removes power to the system. This button should be used only as an extreme measure to remove power to the system. The system can be restarted by pulling the Emergency Stop button out to its original position and following the normal startup process.

Touchscreen

The operator Touchscreen is the user interface to the system. Through this touchscreen the operator can access various screens to control the system, set security, and perform calibrations. The touchscreen also displays the operation of the system as well as displaying warning information.

Power On

Pressing the Power On button activates the system.

Power Off

Pressing the Power Off button initiates a power down sequence to power off the system.

Back of System

The computer and the UPS are accessible from the back of the system.

Figure 2-4: Fortus 900mc Back View

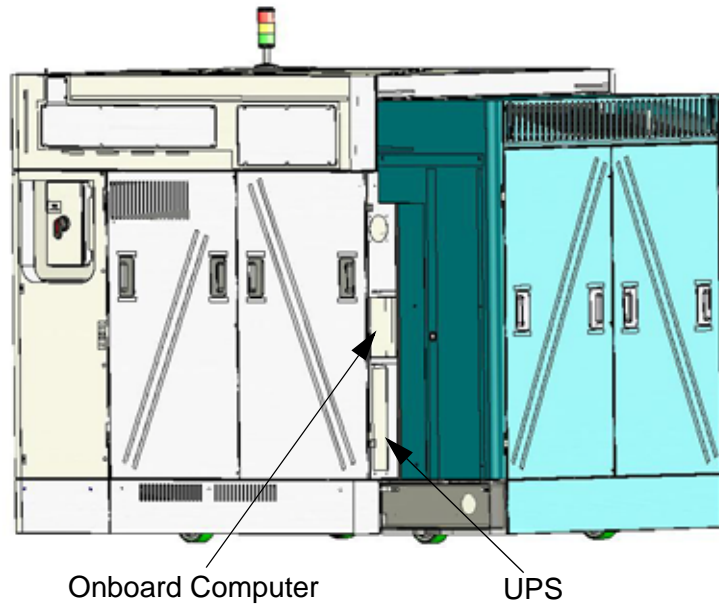

Onboard Computer

The onboard computer is the central control unit for the Fortus 900mc. This computer also runs the touchscreen software that provides for the system's user interface.

UPS

The UPS unit is a battery standby system that supplies power (AC voltage) to the computer, oven lights, and head cooling fan in the event of a loss of AC power. It does not power the entire system. You can access the UPS from the back of the system. In the event of an overcurrent condition, the UPS is protected by a combination on/off switch and circuit breaker located directly above the main breaker.

- It shuts itself off if power is not restored to the system.
- If power is lost to the system you may need to manually power the unit back up. However, this should not be necessary unless the UPS has been manually turned off. To regain power, hold the “On” button on the front of the UPS unit until a beep is heard and/or LED lights appear.
- The LED display shows status of the UPS.

Figure 2-5: UPS Front Panel

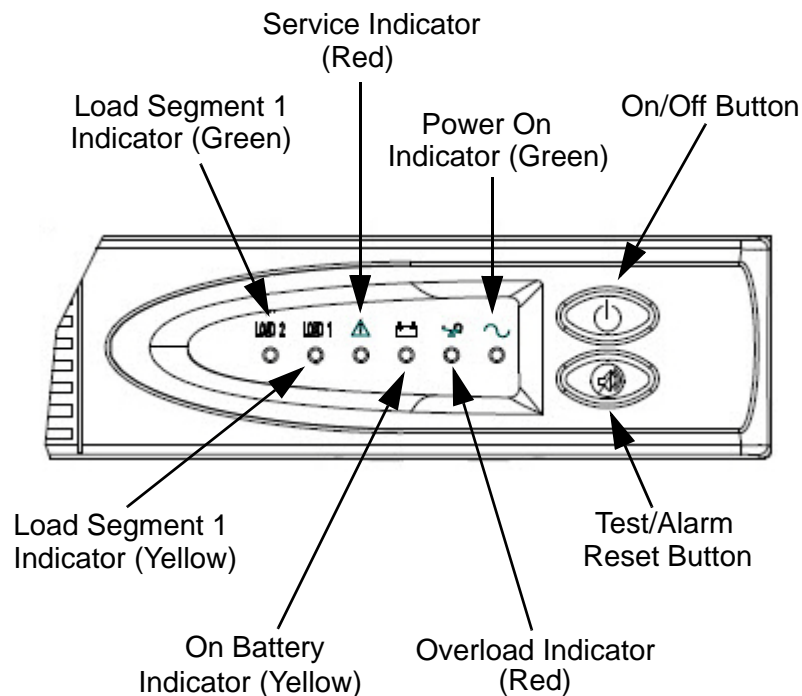

UPS model and display may vary, but functions will be the same (or similar).

System Top

Opening the Top Slide Covers

To access the head, the Top Slide Covers need to be opened. The covers share two safety switches and a locking solenoid. The covers remain locked during system operation or when the user moves the gantry or the Z Stage and are unlocked when the system is idle.

The system cannot resume operation if the top slide covers or the oven door is open. Additionally, a manual move command cannot be sent to the system until both covers and oven are closed.

Gantry Assembly

The Gantry Assembly moves the head in the X and Y axis when building a part. The gantry is located under the top slide covers of the system. The gantry is outside of the oven with only the bottom of the head protruding into the oven. The gantry and its drive motors are thermally shielded from the oven by a heat shield.

Figure 2-6: Gantry Assembly

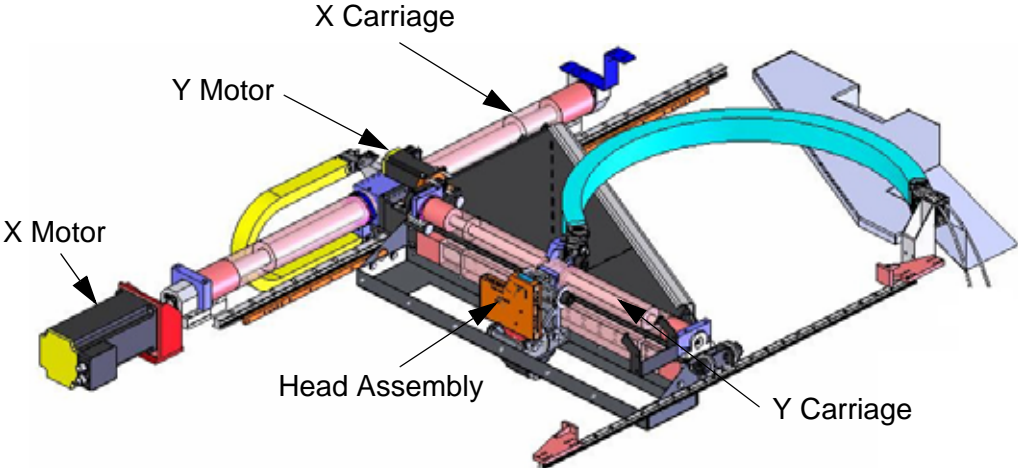

Head Assembly

The Head Assembly (Figure 2-7) is designed for use with a wide range of model materials. The board inside the head provides direct heater and thermocouple control. Model and support material are extruded through the head using two liquefiers.

Figure 2-7: Head Assembly

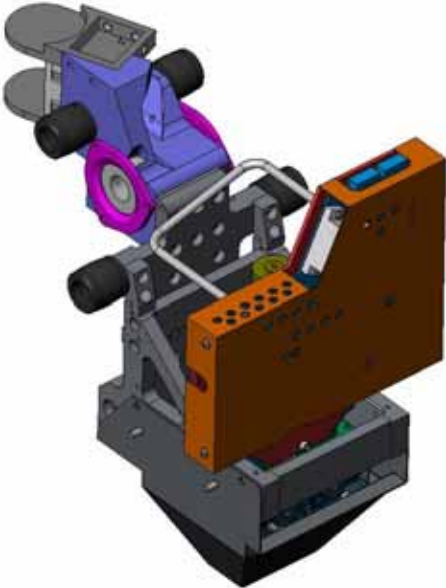

Head Maintenance Bracket

The Head Maintenance Bracket is designed to hold the head assembly while performing maintenance on the head such as tip replacement. (Figure 2-9) The red handle is designed so the top slide covers cannot be closed while the bracket is in place.

Figure 2-8: Head Maintenance Bracket

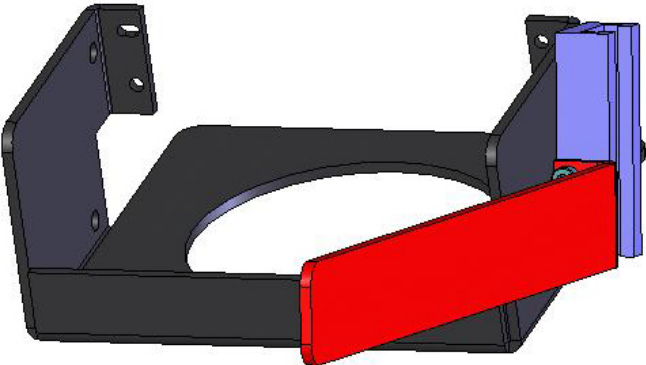
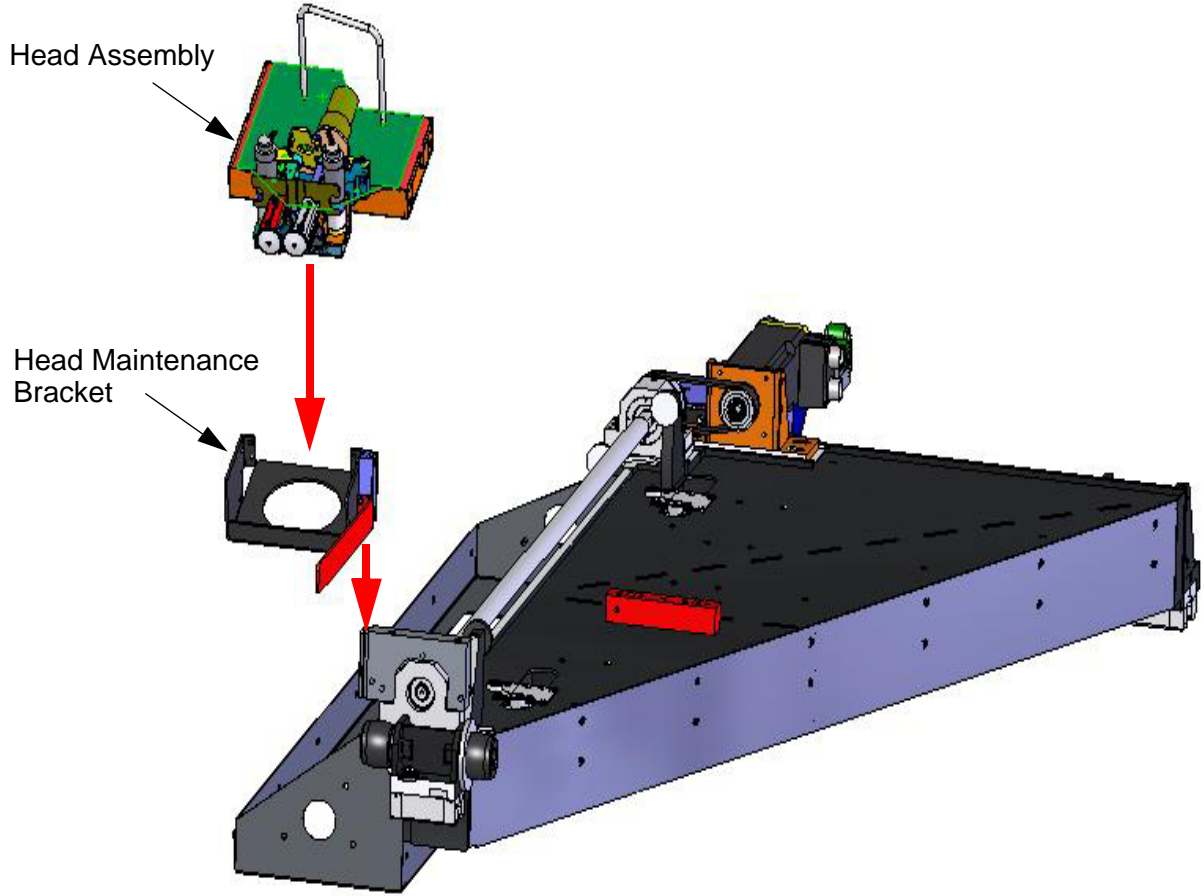

Figure 2-9: Head Assembly Maintenance



Model Materials and Tips

Materials

Materials Used

The Fortus 900mc system can use a variety of material types:

- ABSi model material used with SR-20 soluble support.
- ABS-M30 and ABS-M30i model materials used with SR-20 or SR-30 soluble support. SR-30 is ductile and dissolves up to three times faster than SR-20.
- ABS-ESD7 model material used with SR-30 soluble support.
- UV resistant ASA model material used with SR-30 soluble support.
- Nylon 12 model material, which is the first semi-crystalline Fused Deposition Modeling (FDM) thermoplastic, used with SR-110 soluble support.
- PC-ABS model material used with SR-20 soluble support.
- High strength polycarbonate (PC) model material used with PC_S breakaway support or SR-100 soluble support.
- PC-ISO model material used with PC_S breakaway support.
- Ultem* 9085 model material, which is certified for use on commercial aircraft, used with ULT_S support material.
- Ultem 1010 model material, which offers the highest heat resistance, chemical resistance and tensile strength of any FDM thermoplastic, used with U1010S1 support material.
- Polyphenylsulfone (PPSF) model material, which is ideal for applications in caustic and high heat environments, with PPSF_S support material.

[Table 2-1 on page 2-10](#) lists the build temperatures for each of these materials.

[Table 2-2 on page 2-12](#) lists tip availability for each of these materials.

[Table 2-3 on page 2-12](#) list slice height information for each available tip.

Table 2-1: Material Build Temperatures

Material	Maximum Extrusion Temp	Maximum Oven Temp
ABSi	330° C (626° F)	85° C (185° F)
ABS-M30 ABS-M30i	320° C (609° F)	95° C (203° F)
ABS-ESD7	320° C (609° F)	95° C (203° F)
ASA	330° C (626° F)	100° C (212° F)
Nylon 12	355° C (671° F)	120° C (248° F)
PC-ABS	330° C (626° F)	110° C (239° F)
PC PC-IS0	365° C (689° F)	145° C (293° F)
Ultem* 9085	400° C (752° F)	190° C (374° F)
Ultem 1010	410° C (770° F)	225° C (437° F)
PPSF	415° C (779° F)	225° C (437° F)

All materials use the same canister type. Extrusion and oven temperatures are automatically set by the system.

Materials Compatibility

System/Material compatibility can be found in [“Tip Compatibility and Selection”](#) on page 2-11.

Liquefier Tips

Liquefier Tips and Slice Heights

Two types of liquefier tips are available. Standard tips are used for all model materials and for Break-Away Supports (BASS) materials, and soluble tips are used for soluble support materials. When modeling with materials that use soluble release support material (SR), use either the T12SR20, T12SR30, or T12SR100 tip for the support material.

- There are seven tips available: T12, T12SR20, T12SR30, T12SR100, T14, T16, and T20.
- Tips are a replaceable consumable item. To order tips, see [“Consumable Orders” on page 1-2](#). To change tips, see [“Changing Tips or Material Type” on page 4-50](#).
- Tips must be changed when the material type is changed.

Tip Compatibility and Selection

[Table 2-2](#) lists the materials available for use with the 900mc and their corresponding tips.

[Table 2-3](#) lists the slice heights for each model tip.

[Table 2-4](#) provides approximate tip life, based on the amount of material used.

- The system tracks tip use and automatically prompts you, through the Operator Touchscreen, when a tip should be replaced. Worn tips are prone to clogs and reduce part quality. See [“Materials/Tools Display” on page 4-10](#) for more information on viewing tip use status.
- When changing tips, the Tip Wizard will guide you through resetting the tip odometers from the display panel.
- If building with ABS-M30 or ABS-M30i, you can use either SR-20 or SR-30 support material.
- If using SR-20 material, use T12SR20 tip only (previously called a T12SR tip).
- If using SR-30 material, use T12SR30 tip only.
- If using SR-100 material, use T12SR100 tip only.
- If using SR-110 material, use T12SR100 tip only.

The standard tip is used for Break-Away Supports (BASS) and model material. See [“Tip Identification” on page 2-15](#) for more information.

Table 2-2: Available Tips

Model Material	Model Tip	Support Material	Support Tip
ABSi	T12, T16, T20	SR-20	T12SR20
ABS-M30 ABS-M30i	T12, T16, T20	SR-20 SR-30	T12SR20 T12SR30
ABS-ESD7	T12, T16	SR-30	T12SR30
ASA	T12, T16, T20	SR-30	T12SR30
Nylon 12	T12, T16, T20	SR-110	T12SR100
PC-ABS	T12, T16, T20	SR-20	T12SR20
PC	T12, T16	SR-100	T12SR100
PC PC-ISO	T12	PC_S	T12
PC PC-ISO	T16, T20	PC_S	T16
Ultem* 9085	T16, T20	ULT_S	T16
Ultem 1010	T14	U1010S1	T16
PPSF	T16	PPSF_S	T16

Table 2-3: Slice Height

Model Tip	Slice Height
T12	0.007 in. (0.178 mm)
T14	0.010 in. (0.254 mm)
T16	0.010 in. (0.254 mm)
T20	0.013 in. (0.330 mm)

Table 2-4: Tip Life

Model ^a Material	Model Tip	Model Tip Life ^b			Support Tip	Support Tip Life ^b		
		cu. in.	cu. cm.	Canisters		cu. in.	cu. cm.	Canisters
ABSi	T12	770	12620	8.5	T12SR20	550	9010	6.0
ABSi	T16	920	15080	10.0	T12SR20	640	10550	7.0
ABSi	T20	920	15080	10.0	T12SR20	640	10550	7.0
ABS-M30 ABS-M30i	T12	770	12620	8.5	T12SR20 T12SR30	550	9010	6.0
ABS-M30 ABS-M30i	T16	920	15080	10.0	T12SR20 T12SR30	640	10550	7.0
ABS-M30 ABS-M30i	T20	920	15080	10.0	T12SR20 T12SR30	640	10550	7.0
ABS-ESD7	T12	770	12620	8.5	T12SR30	550	9010	6.0
ABS-ESD7	T16	920	15080	10.0	T12SR30	640	10550	7.0
ASA	T12	770	12620	8.5	T12SR30	550	9010	6.0
ASA	T16	920	15080	10.0	T12SR30	640	10550	7.0
ASA	T20	920	15080	10.0	T12SR30	640	10550	7.0
Nylon 12	T12	491	8050	5.3	T12SR100	550	9010	6.0
Nylon 12	T16	552	9010	6.0	T12SR100	664	10880	7.1
Nylon 12	T20	552	9010	6.0	T12SR100	664	10880	7.1
PC-ABS	T12	550	9010	6.0	T12SR20	550	9010	6.0
PC-ABS	T16	828	13570	9.0	T12SR20	664	10550	7.0
PC-ABS	T20	828	73570	9.0	T12SR20	664	10550	7.0
PC	T12	740	12060	8.0	T12 T12SR-100	370 550	6030 9013	4.0 6.0
PC	T16	830	13570	9.0	T16 T12-SR100	460 644	7540 10553	5.0 7.0
PC	T20	830	13570	9.0	T16	460	7540	5.0
PC-ISO	T12	740	12060	8.0	T12	370	6030	4.0
PC-ISO	T16	830	13570	9.0	T16	460	7540	5.0

Model ^a Material	Model Tip	Model Tip Life ^b			Support Tip	Support Tip Life ^b		
		cu. in.	cu. cm.	Canisters		cu. in.	cu. cm.	Canisters
PC-ISO	T20	830	13570	9.0	T16	460	7540	5.0
Ultem* 9085	T16	550	9010	6.0	T16	460	7540	5.0
Ultem* 9085	T20	550	9010	6.0	T16	460	7540	5.0
Ultem 1010	T14	552	9010	6.0	T16	460	7540	5.0
PPSF	T16	180	3010	2.0	T16	180	3010	2.0

- a. ABSi model material uses SR-20 support material. A T12SR20 support tip should be used (regardless of model tip size).
 ABS-M30 and ABS-M30i model material can use SR-20 or SR-30 support material. Use the T12SR20 tip for SR-20 material (regardless of model tip size) and use the T12SR30 tip for SR-30 material (regardless of model tip size).
 ABS-ESD7 and ASA model material uses SR-30 support material. A T12SR30 support tip should be used regardless of model material tip size.
 Nylon 12 model material uses SR-110 support material. A T12SR100 support tip should be used (regardless of model material tip size).
 PC-ABS model material uses SR-20 support material. A T12SR20 support tip should be used (regardless of model tip size).
 PC model material uses either SR-100 or PC_S support material. When using PC_S the support tip matches model tip size for T12 and T16, while T20 uses a T16 support tip. When using SR-100 use the T12SR100 support tip (regardless of model tip size).
 PC-ISO model material uses PC_S support material. Support tip size matches model tip size for T12 and T16, while T20 uses a T16 support tip.
 Ultem* 9085 model material uses ULT_S support material. A T16 support tip should be used regardless of model material tip size.
 Ultem 1010 model material uses U1010S1 support material. A T14 model tip should be used with a T16 support tip.
 PPSF model material uses PPSF_S support material. Support tip size matches model tip size.
 Nylon 12 model material uses SR-110 support material. A T12SR100 support tip should be used regardless of model material tip size.

- b. Tip Life is directly related to the amount of material that passes through the tip. The amounts listed above are approximates of how much material will pass through a tip before the tip will need to be replaced. Because other factors can affect tip life, the material amounts are only approximates.

Tip Identification

Figure 2-10: Tip Identification

All unused model and support tips are interchangeable - EXCEPT for Soluble Release support tips. Once a tip is used, it is committed to that material type and is no longer interchangeable.

Model tip size is imprinted on the top side of the plate (T12, T14, T16, T20).

The Soluble Release support tip is shorter than standard tips.

Support tip size is imprinted on the top side of the plate (T12SR20, T12SR30, T12SR100).

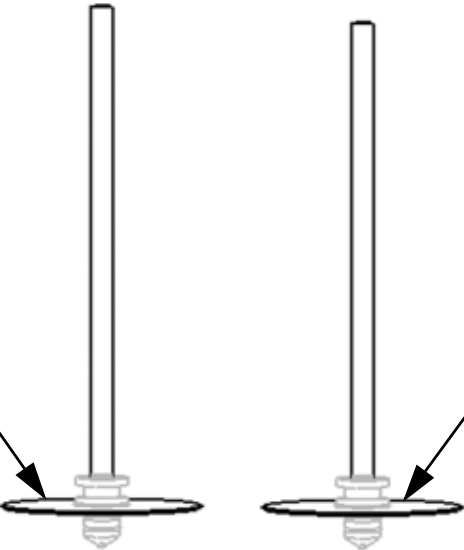

Oven

Oven Door

The oven door is locked by a solenoid during the building of a part. Pressing the Door button on the Operator Touchscreen will release the solenoid allowing you to open the door. This command is available only while the system is paused or in an idle state. You do not have access to this command while any mechanism in the system is moving.

 By design, the oven door can be partially opened while locked. Do not force the oven door open by pulling on it while the locking solenoid is engaged.

From the Operator Touchscreen, press the **Door** button to unlock the oven door. (Figure 2-11)

Figure 2-11: Open Door Icon



 Once the oven door is unlocked and/or opened, system operation cannot be resumed. Additionally, a manual move command cannot be sent until the oven door is closed. When the oven door is closed, the solenoid activates and operation can resume.

Oven Components

 **Warning:** Oven lights are hot! Do not touch without wearing approved safety gloves.

Oven Lamps

There are two incandescent oven lamps mounted in the two front upper corners of the oven. The 40 watt lamps are rated at 240 volts. There is a lamp (light) switch on the touchscreen, which you can use to manually turn the light ON or OFF. (Figure 2-12)

Figure 2-12: Oven Lamp

Light



Platen

The platen is the surface on which parts are built. A plastic build sheet is held to the 36 in. (91.4 cm) X 24 in. (61.0 cm) aluminum platen by the vacuum source. The platen has a waffle pattern system into the top surface. This allows vacuum to pull across the entire surface. A small build sheet 16 in. (40.6 cm) X 18.5 in. (47.0 cm) can be used in the center zone of the platen.

Debris screens (not a customer removal part) are placed across the vacuum ports to prevent material particles from entering the vacuum lines.

Figure 2-13: Vacuum Platen Components

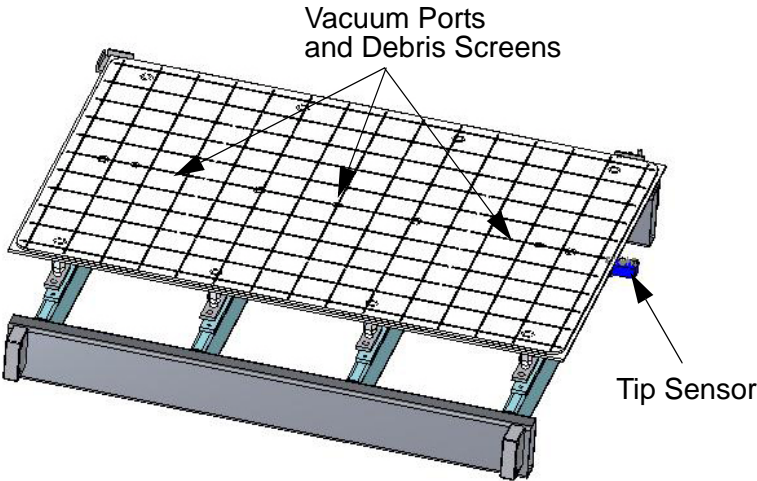

The Tip Cleaning Assembly is located to the front, right side of the oven. The assembly consists of two flicker/brush assemblies (1 for each tip) and a debris chute. The flicker/brush assemblies keep the liquefier tips free of debris and material buildup. The debris chute directs debris into the purge bucket located under the tip cleaning assembly.

Figure 2-14: Tip Cleaning Assembly

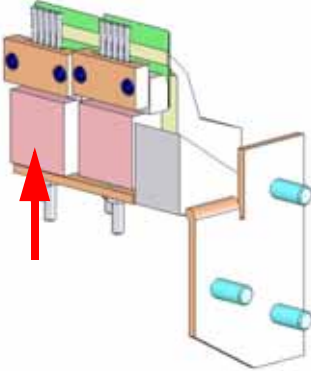

Purge Bucket

The debris chute directs debris into the purge bucket located under the tip cleaning assembly inside the oven chamber. The purge bucket is designed to catch debris from the tip cleaning assembly and collects model and support filament waste. The purge bucket is removable from the system and has a door at the bottom of the basket for waste disposal.

Figure 2-15: Purge Bucket

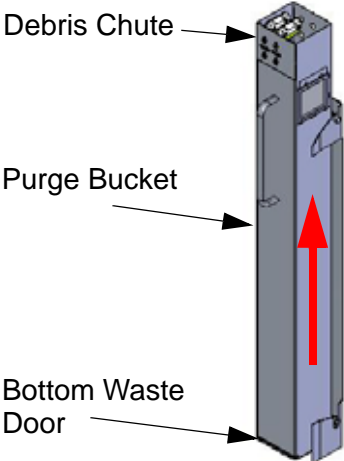

Canister Bay

Accessing the Bays

The four canister bays are accessed by opening the canister bay door on the front of the system (Figure 2-16). The canister bay door is not a part of the door safety interlock system and can be opened during system operation.

Figure 2-16: Canister Bay Components

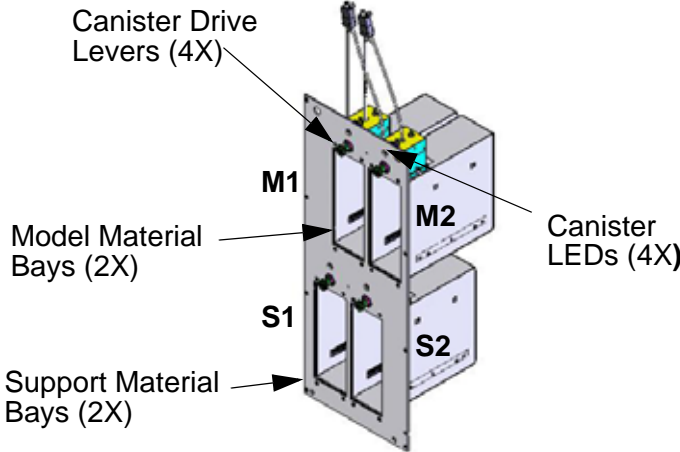

Canister Bay Components

The Fortus 900mc system has four operating material bays - 2 model and 2 support. The upper two bays hold model material; the bottom two bays hold support material. While building, two canisters will be active. An active canister has material filament loaded to the liquefiers (steady green LED).

- Inactive canisters can be replaced without pausing the system.

Each individual canister bay has a material drive block and a drive lever (Figure 2-17). The drive lever is used to engage (and disengage) the drive block with the canister. The drive block feeds the filament from the canisters to the liquefiers.

- The drive block is located above the canister which drives the filament up to the liquefiers.
- The drive block is spring loaded and moves up and down on guide pins. The spring provides positive pressure for the drive block against the top of the canister.
- The drive block contains a material sensor. The sensor is used to communicate to the system when material is available to be loaded to the liquefiers.

Figure 2-17: Drive Block Lever

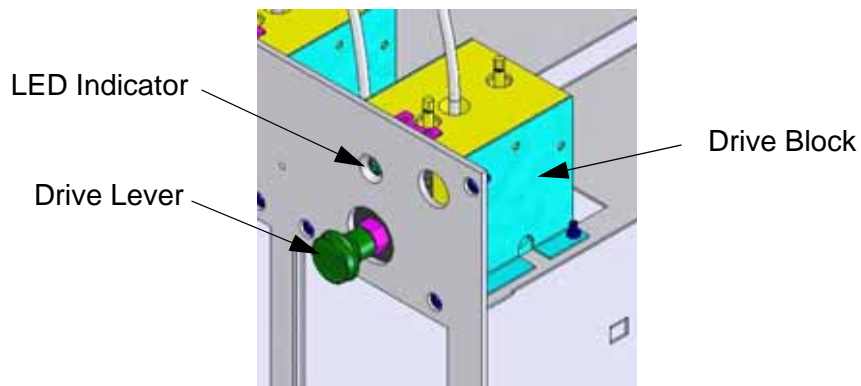

There is one colored LED light above each canister. The LED indicates the canister condition for each bay (Figure 2-16):

- Green - Steady. Material filament has been loaded into the liquefiers. You cannot remove the canister when the LED is a steady green.
- Green - Flashing (Ready state). Filament has been fed into the canister drive block but is not loaded into the liquefiers. You can unload canisters if necessary.
- Red - Steady. The canister is empty. You can unload the canister if necessary.
- Red - Flashing. The canister has a load failure or a smart-spool-chip read/write failure. You can unload canisters if necessary.

- Off. No canister is present, or the canister is present but the filament has not been fed into the canister drive block.

SmartSpool System

The Fortus 900mc uses the SmartSpool system to provide canister information. This allows you to manage material resources, and maximize part build strategies for long, unattended part builds. Each canister contains an encoded chip (Figure 2-18) that tracks the status of the canister material. Canister information is reported to the system and displayed on the Operator Touchscreen.

Figure 2-18: SmartSpool Canister

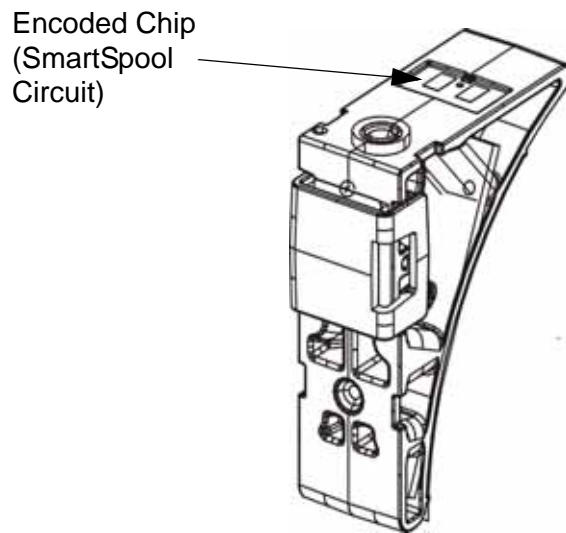

Chapter 3: Setup and Installation

3

This chapter describes basic setup and installation of the Fortus 900mc system.

General Information

Prepare Your Facility for Installation

Follow the Fortus 900mc Site Preparation Guide to ensure that your facility is effectively and safely prepared for system installation.

Identifying Your System

Use the following label to identify your system: (Figure 3-1)

- Serial Number - Refer to this number when requesting service.
- Model - The model number, the power requirements, and the company's address and phone number are given on the label. All patent numbers associated with the system are also listed on the label.
- The label is located on the back of the system on the main electrical box.

Figure 3-1: System Label

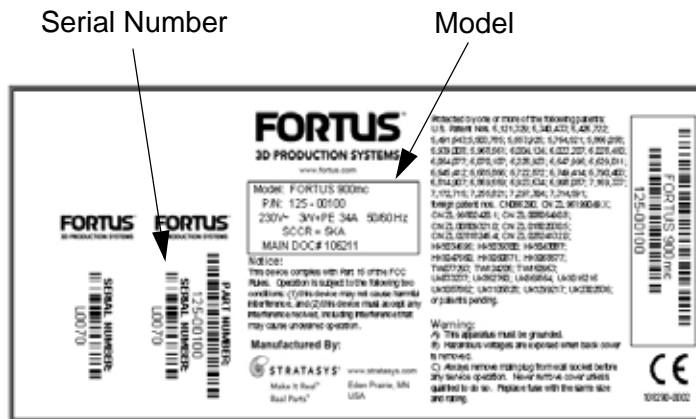

Basic Setup

Making the Network Connection

Processed job files are transferred to the Fortus system through your facility's Ethernet network. An RJ45 network connector is located on the top right-hand corner at the back of the system.

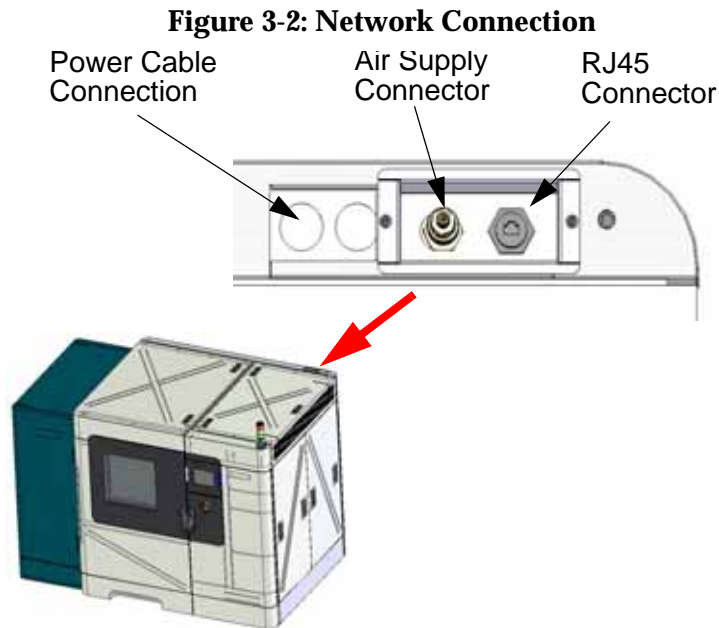

Air Supply Connection

An air supply connection is located on the top right-hand corner at the back of the system (Figure 3-2).

Making the Power Cable Connection



Warning: A licensed electrician must perform all wiring from service connect to the transformer, and from the transformer to the system - including all connectors, cables and proper strain relief.

This system requires a high voltage connection, which is made at the top right-hand corner at the back of the system (Figure 3-2). High voltage is applied to the system using a Delta connection. The main breaker must be off until a Stratasys authorized Service Technician has verified the connection. This system is only provided with a Delta connection (Figure 3-3).

Figure 3-3: Power Cable Connection

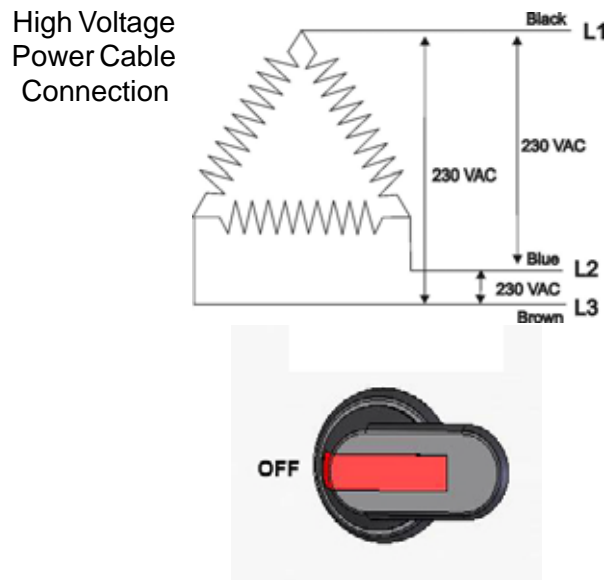

Network Setup

Your system is configured for your network as a part of its initial installation and setup. This section is provided in case you have need to change your network settings.

Configuring the Network

1. The network address can be Dynamic or Static.
 - Dynamic address - a network server or PC will generate an IP address for the system. A different IP address may be generated from time to time by the server or PC.
 - Static address - you must enter an IP address, network mask, and gateway address for the system (provided by the system administrator). Once entered, the address will not change.
2. In addition to configuring the IP address, you can set the UPnP configuration for the system.
 - UPnP ON - the system will broadcast its (Unique Device Name) UDN address across the network. This allows the Insight workstation software to automatically detect the IP address of the system for communication.
 - UPnP OFF - the system will not broadcast its IP address across the network. The Insight workstation software will need to be manually configured to communicate with the system.

Setting the IP Address

1. Power up the system (see “Powering On the System” on page 4-32).

The following Building Screen on the Operator Touchscreen will appear when the Fortus 900mc is powered up. (Figure 3-4):

Figure 3-4: Building Screen

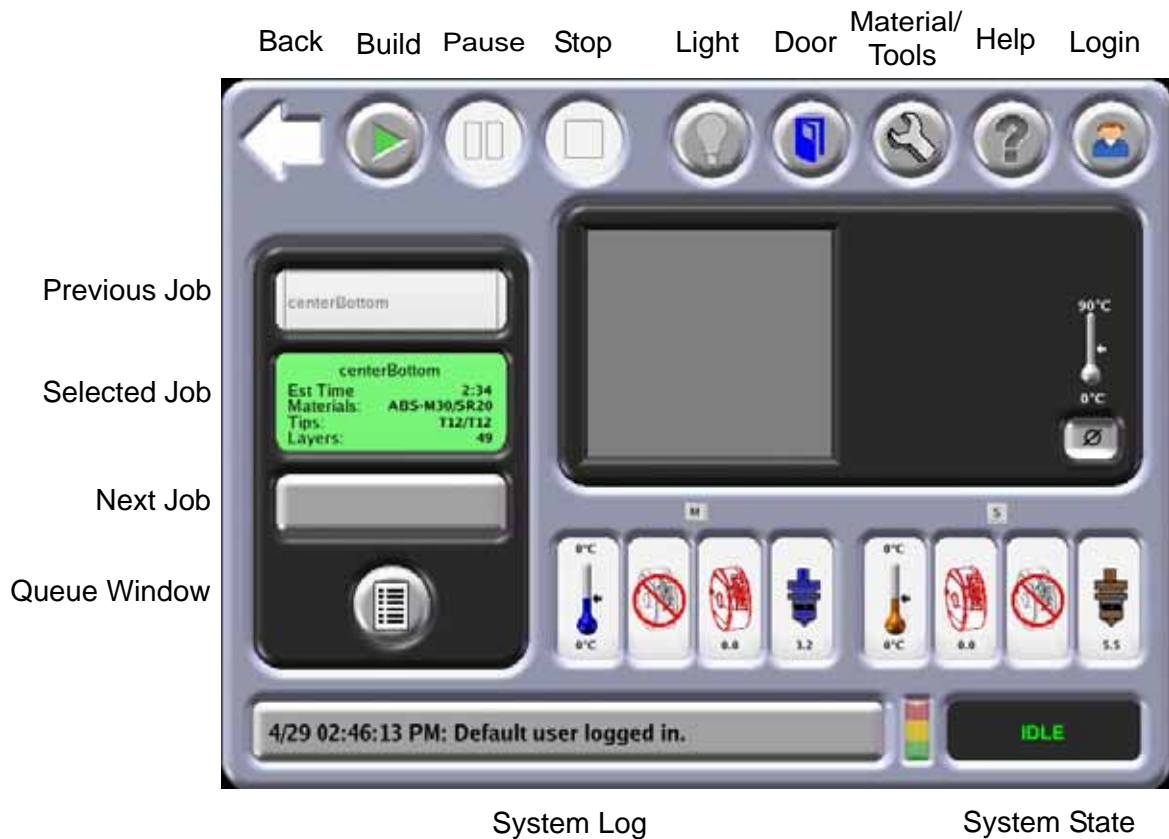

1. Select one of the categories displayed on the Login screen.

Figure 3-5: Login Screen

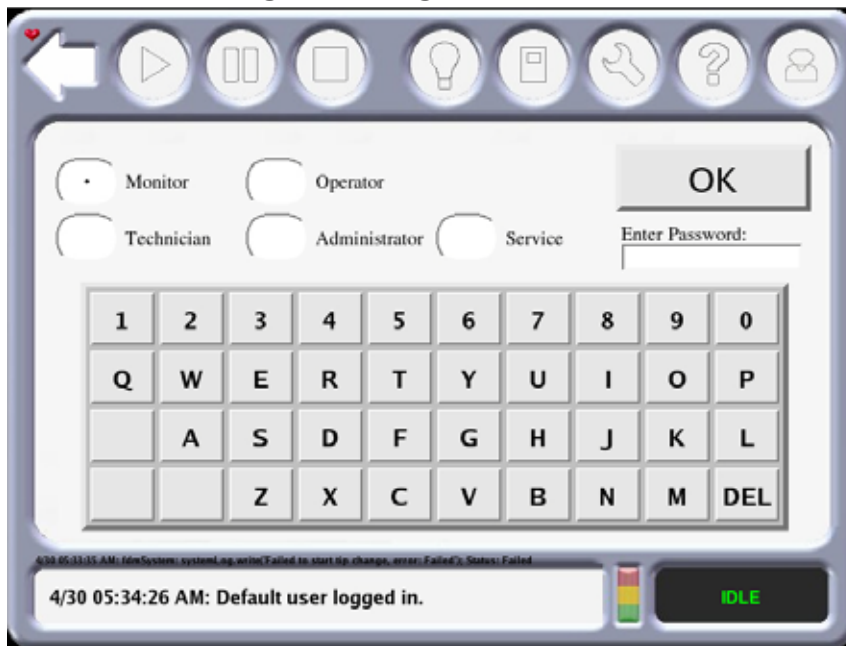

2. After one of the categories is selected, enter the password using the touchscreen keypad and then press **OK**.
3. From the Building Screen, press the **Material/Tools** icon and then the **Administrator** icon and the following screen will appear on the touchscreen.

Figure 3-6: Administrator Screen

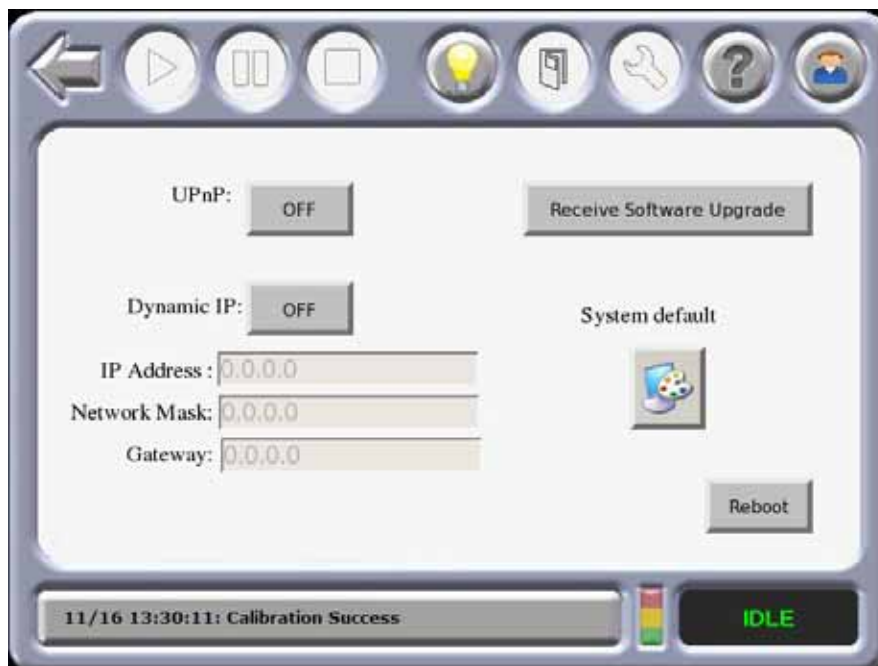
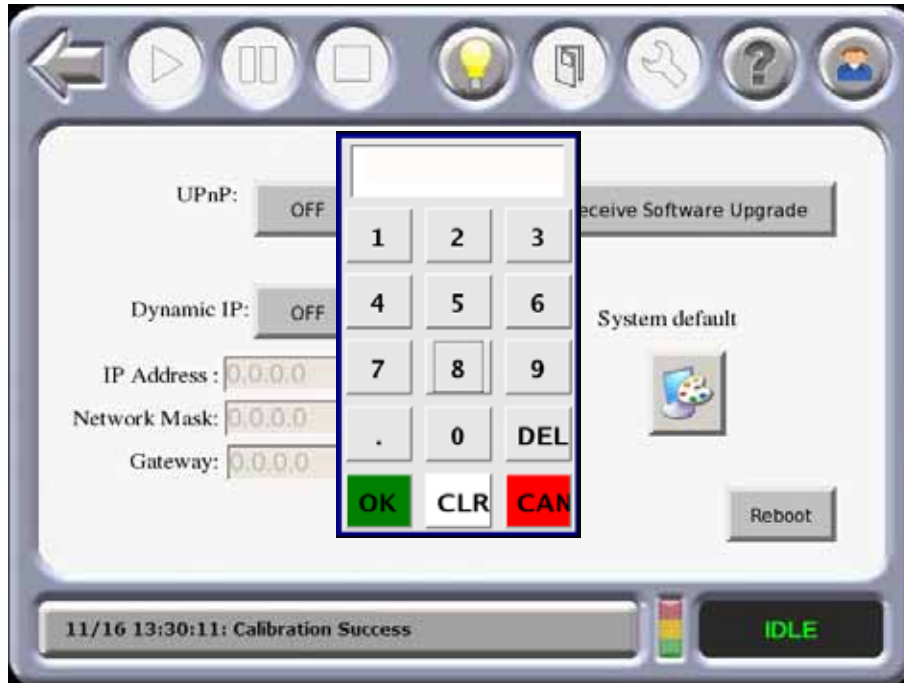



Figure 3-7: Administrator Screen with Key Pad



4. From the Administrator screen, press the IP address box desired and enter the address using the touchscreen keypad.
5. Press the **Network Mask** box desired and enter the numbers using the touchscreen keypad.
6. Press the **Gateway** box desired and enter the numbers using the touchscreen keypad.
7. Press the **Back** icon to exit and return to the Main Menu.

 See your system administrator if you do not know the IP, Network Mask, or Gateway address.



Chapter 4: Operating the System

4

This chapter explains basic steps in operating the Fortus 900mc system.

Basic User Interface and Operations

The Operator Touchscreen is located on the front of the system. Icons are displayed on the screen that are universal and intuitive to use.

Figure 4-1: Operator Touchscreen

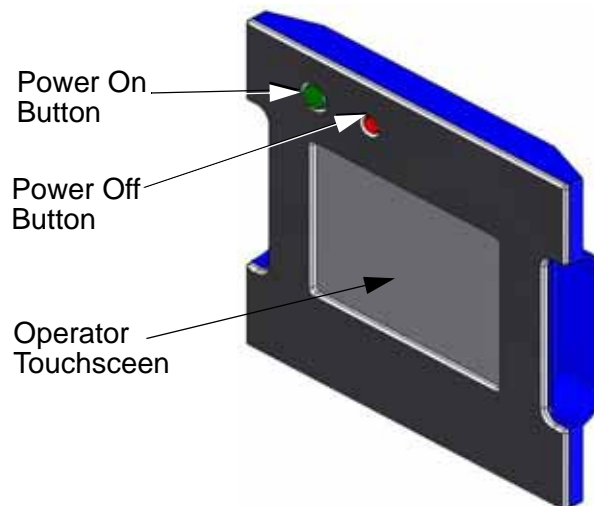

The Operator Touchscreen (Figure 4-1) allows you to:

- Access material loading and unloading functions along with access to calibration.
- Monitor system status.
- Monitor material status (type loaded and amount).
- Monitor job status (number of hours completed, number of hours total, current build height and total build height, and the name of job currently being built).
- Initiates a system power ON or a power OFF.
- Access network configuration.

- Access the job queue.
- Access the sample job queue.

Using the Touchscreen

The following touchscreen displays the building screen of the Fortus 900mc system (Figure 4-2):



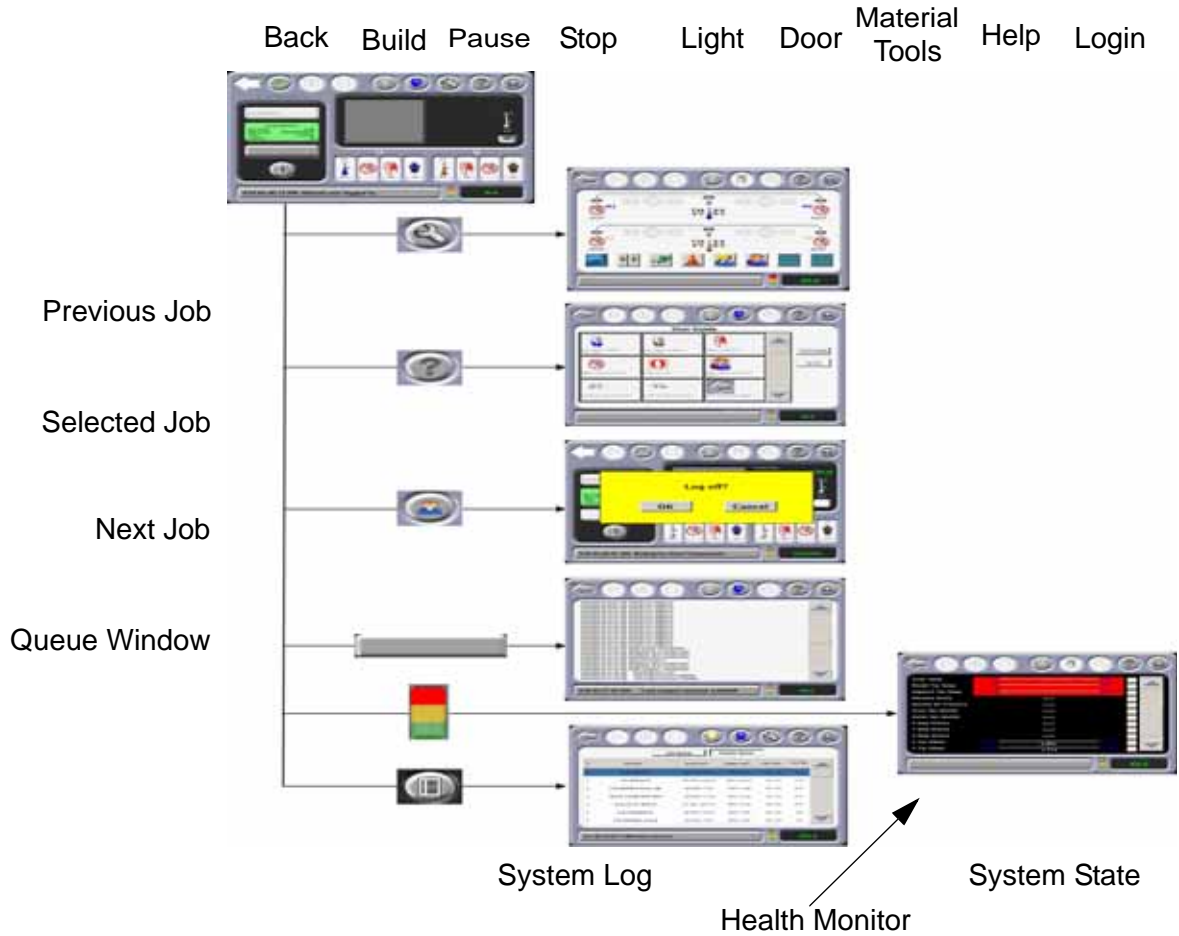
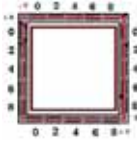

Figure 4-2: Building Screen

















Touchscreen Buttons







The following table displays the button icon and presents a brief description the button function

Touchscreen Icons

Button	Description
Administration 	Opens the Administration window.
Back 	Displays the previous window.
Build 	Initiates the building of a part.
Calibration XYZ 	Opens the Calibration XYZ window.
Cancel 	Cancels the current operation. Note: Pressing the cancel button may be delayed while the current operation completes. In the event of an emergency, use the emergency stop button.
Default Setting 	Opens the Default Setting window. Note: Pressing this button does not reset the default settings.





Button	Description						
Door/Covers 	Unlocks the oven door and the top slide covers.						
Health Monitor 	Opens the Health Monitor window.						
Help 	Opens the Help menu on the touchscreen.						
Jobs 	<table border="0"> <tr> <td data-bbox="662 909 836 961">Previous Job</td> <td data-bbox="852 909 1235 961">Causes the last build to be the selected build.</td> </tr> <tr> <td data-bbox="662 972 836 1024">Selected Job</td> <td data-bbox="852 972 1235 1024">Displays the current job being built.</td> </tr> <tr> <td data-bbox="662 1035 836 1087">Next Job</td> <td data-bbox="852 1035 1235 1087">Causes the next job to be the selected job.</td> </tr> </table>	Previous Job	Causes the last build to be the selected build.	Selected Job	Displays the current job being built.	Next Job	Causes the next job to be the selected job.
Previous Job	Causes the last build to be the selected build.						
Selected Job	Displays the current job being built.						
Next Job	Causes the next job to be the selected job.						
Load/Unload 	Loads or unloads the canister.						
Login 	Logs on or off the system.						
Materials/Tools 	Opens the Materials/Tools window.						







Button	Description
Move Down 	Moves the object down.
Move Left 	Moves the object to the left.
Move Right 	Moves the object to the right.
Move Up 	Moves the object up.
Operator Tools 	Opens the Operator Tools window.
Oven Light Off 	When pressed, the oven light is turned on.
Oven Light On 	When pressed, the oven light is turned off.
Pause 	Causes the system to temporarily stop building. Press the Build button to restart. Note: Pressing the pause button may be delayed while the current operation completes.



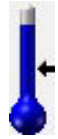

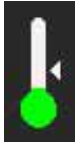

Button	Description
Queue Window 	Displays a list of jobs that are queued and ready to be built.
Stop 	Stops a current build or calibration.
Stop 	Stops motion.
System Log 	Displays the latest system message. Pressing the system log button displays a history of system messages. Pressing the System Log button again clears the current message from the button.
System Status 	Opens the System Status window.
Tip Wizard 	Starts the Tip/Material change wizard.
XYZ 	Auto Home XYZ.

Touchscreen Symbols

The following symbols are used in the menu displays.

Symbol	Description
<p>Canister</p> 	<p>Good model canister. The type of material is displayed above the icon and the amount of material remaining in the canister is shown below the icon. The amount is given in cubic inches or cubic centimeters depending on the machine display units.</p>
<p>Canister</p> 	<p>Good support canister. The type of material is displayed above the icon and the amount of material remaining in the canister is shown below the icon. The amount is given in cubic inches or cubic centimeters depending on the machine display units.</p>
<p>Empty Canister</p> 	<p>Empty canister.</p>
<p>Empty Canister Bay</p> 	<p>No canister in bay.</p>
<p>Model Tip</p> 	<p>Good model tip. This icon is accompanied with an odometer reading displayed at the bottom of the icon. The type size is displayed above the icon.</p>

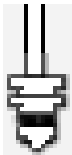
Symbol	Description
Model Tip at Setpoint 	Model Tip temperature is at setpoint.
Model Tip Cooling Down 	Model Tip temperature is cooling down.
Model Tip Heating Up 	Model Tip temperature is heating up.
Oven at Setpoint 	Oven is at setpoint.
Oven Cooling Down 	Oven is cooling down.
Oven Heating Up 	Oven is heating up.
Step Complete 	Step complete.

Symbol	Description
Support Tip 	Good support tip. This icon is accompanied with an odometer reading displayed at the bottom of the icon. The tip size is displayed above the icon.
Support Tip at Setpoint 	Model Tip temperature is at setpoint.
Support Tip Cooling Down 	Model Tip temperature is cooling down.
Support Tip Heating Up 	Model Tip temperature is heating up.
Tip (Flashing) 	Tip is plugged or failed to load.
Tip Past Odometer 	Tip is past odometer limit.
Waiting 	Waiting for a step to be completed.

Materials/Tools Display

This window displays the current status of the modeler and support filament, canister status, and tip size and setpoint and the actual temperature of the tips. The color of the tips will turn blue (for model) and brown (for support) when material is fully loaded.

Figure 4-3: Materials/Tools Display

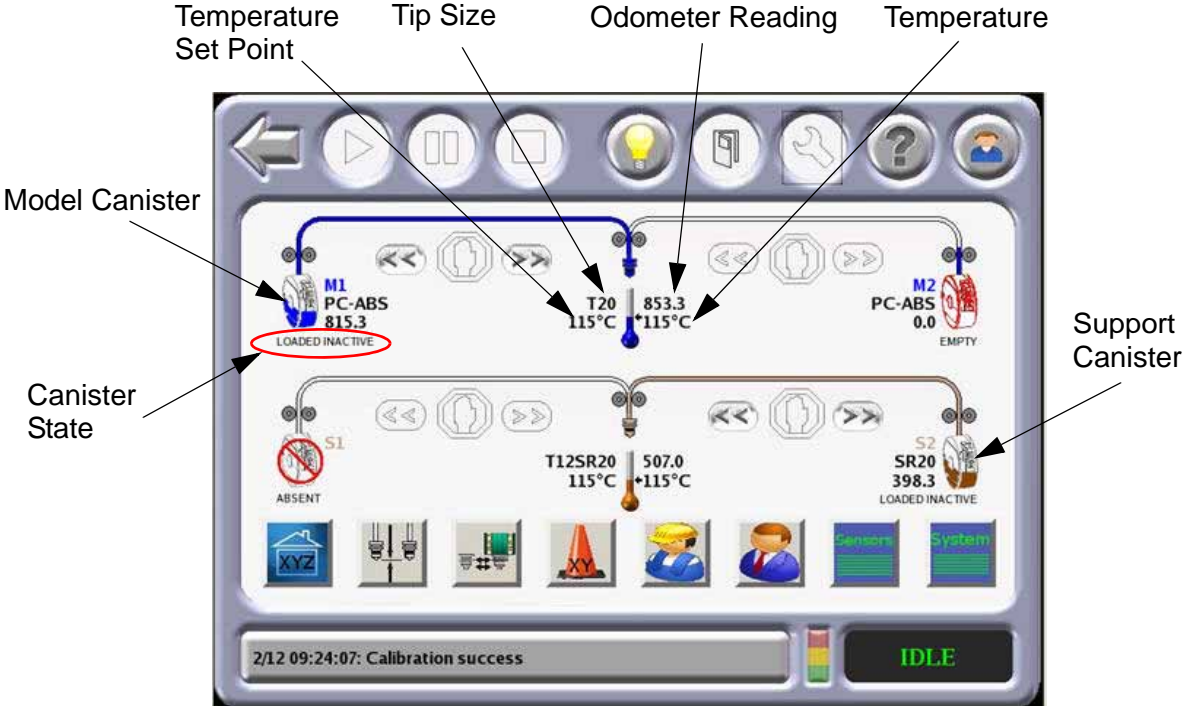

Canister State

A variety of messages will be temporarily displayed under the canister icon to show the current activity of the canister/filament.

Queue Window

The Queue menu contains files downloaded from the Insight application on your PC workstation.

- Job Queue displays current jobs that are waiting in the queue.
- A list of stored sample jobs can be displayed by pressing the Sample Queue icon.

 The jobs listed in either queue can be arranged by pressing any of the categories (i.e., Job Name, Materials, Tips, or Build Time).

Figure 4-4: Queue Window



Sensor Status

The Sensor Status window displays dynamic information of the status of the system. The following information is displayed.

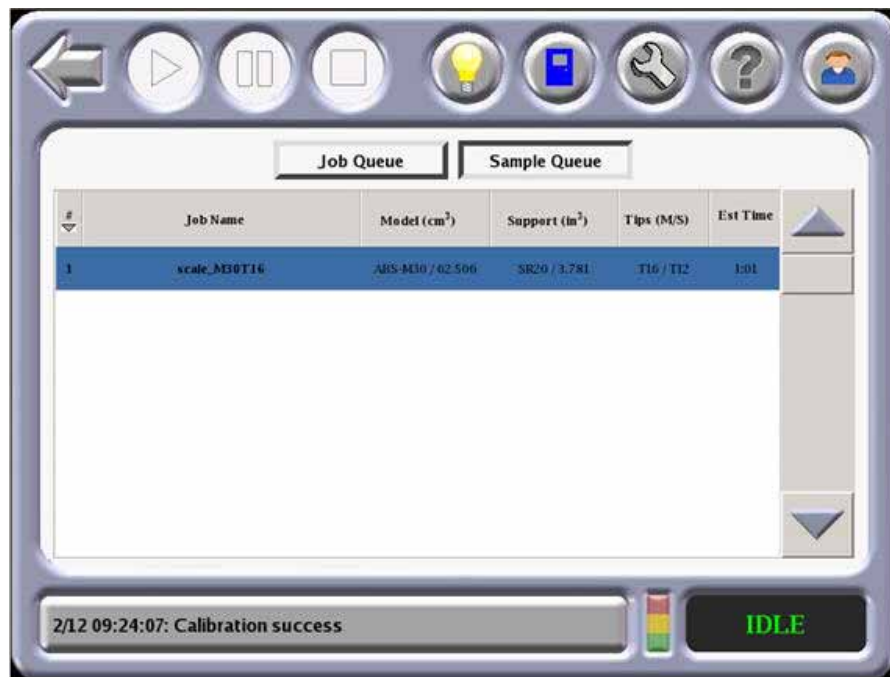
- Temperature of the oven, model and support temperatures along with setpoints
- Limit Switch detection
- Oven door and top cover slide locks
- Inner and outer vacuum status
- Motion fault, UPS state, machine state, AC contactor status, and tip sensor
- Support and model filament motor status
- Sense head switch 1 and 2
- Filament at model and support head

Figure 4-5: Sensor Status

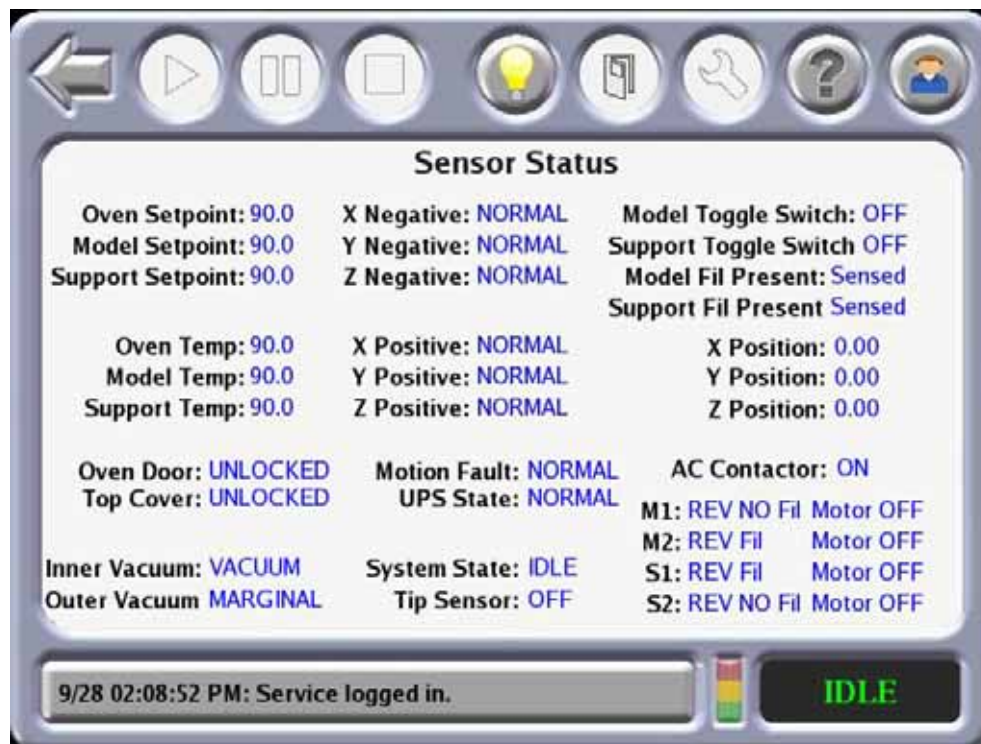

System Status

The System Status window displays product data, software and network information, along with canister firmware and UPS status.

Figure 4-6: System Status

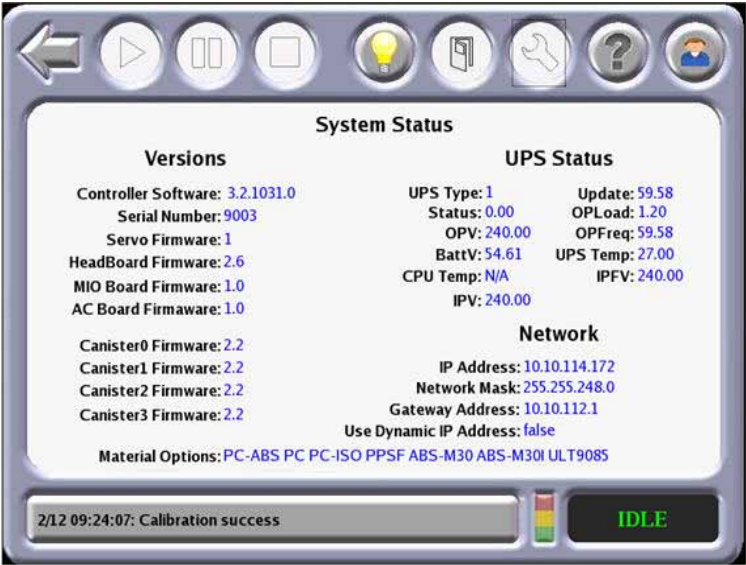

System Defaults

System Defaults can be changed in this window. Units can be displayed in English or metric. User placement can be turned on or off.

Figure 4-7: System Defaults



System Log

Displays a log of events that have taken place on the system. The log list is cleared when the system is powered down or there is a loss of power. Pressing the system log button displays a history of system messages. Pressing the System Log button again clears the current message from the button.

Figure 4-8: System Log



Technician Menu

The Technician Menu allows the user to move the platen up or down and the head in the X and Y axis. Movements can be selected in units of 1, 10ths, 100ths or 1000ths of an inch or in millimeters (as shown in figure below).

Figure 4-9: Technician Menu



Tip Offset Menu

This menu allows the user to adjust the XYZ calibration offsets. The thickness of the support material can also be adjusted. After adjustment, the user can press the Build Calibrations Box to verify the calibration.

Figure 4-10: Tip Offset Menu

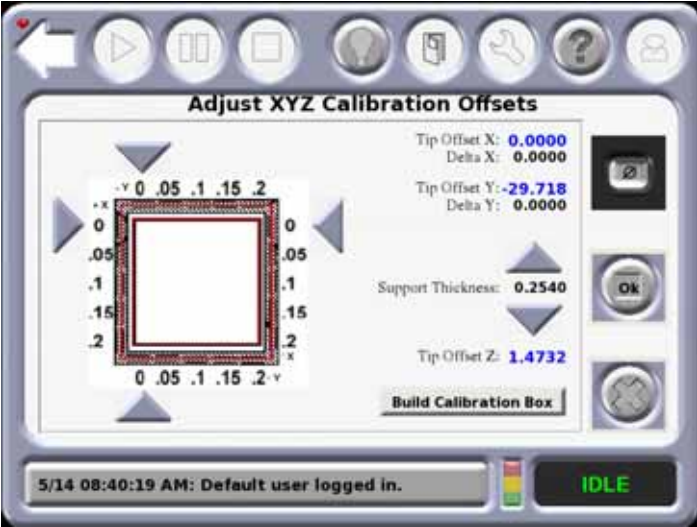

Part Placement Menu

The Part Placement window allows the user to move the part manually to a position on the build sheet. The part is moved by touching the black box outline of the part and dragging it to the desired location. Shadows of previous builds appear as grey boxes. These can be cleared by pressing the "Clear" button. The part outline cannot be dragged outside the currently installed build sheet.

Figure 4-11: Part Placement Menu

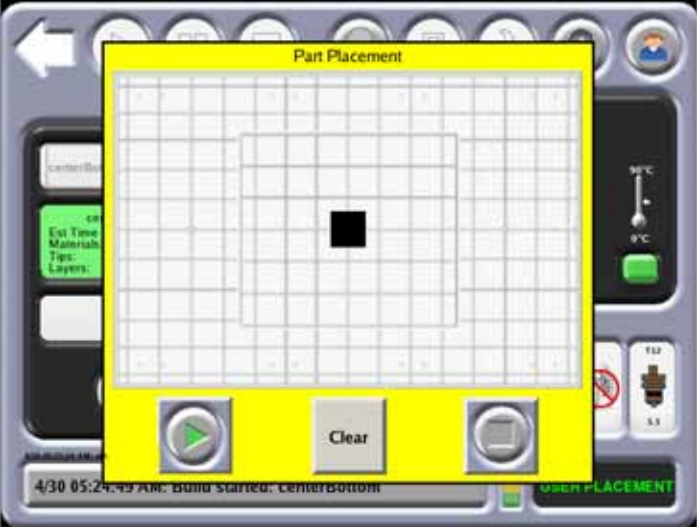

Administrator Menu

The Administrator Menu allows an administrator to change the parameters of the system. Software upgrades are accomplished through this window as well as setting system defaults.

Figure 4-12: Administrator Menu



A keypad is displayed for entering numbers after selecting an IP address, a network mask or gateway number.

Figure 4-13: Administrator Menu With Keypad



System Default Values

System defaults can be changed from the System Default menu.

Figure 4-14: System Default



Display Units

Select Display Units.

- Inches or metric can be selected (factory setting is in English).

User Placement

The part build location can be viewed or changed from the User Placement button.

1. If User Placement is set to Off (default), the part will build in the center of the platen.
2. If User Placement is set to On, the position of the part can be position on the platen by the user. The part can be position by dragging and dropping the part using the Operator Touchscreen. The part cannot be outside the limits of the build sheet.

Auto Cool Oven

If the Auto Cool Oven is set to on, the oven will cool to the standby temperature.

Enable Security

Planned for future development.

Building Screen

The Building Screen displays the progress of the part being built. Oven temperature is displayed as well as platen vacuum for large and small build sheets. The icon will turn green when vacuum is present.

Figure 4-15: Building Screen

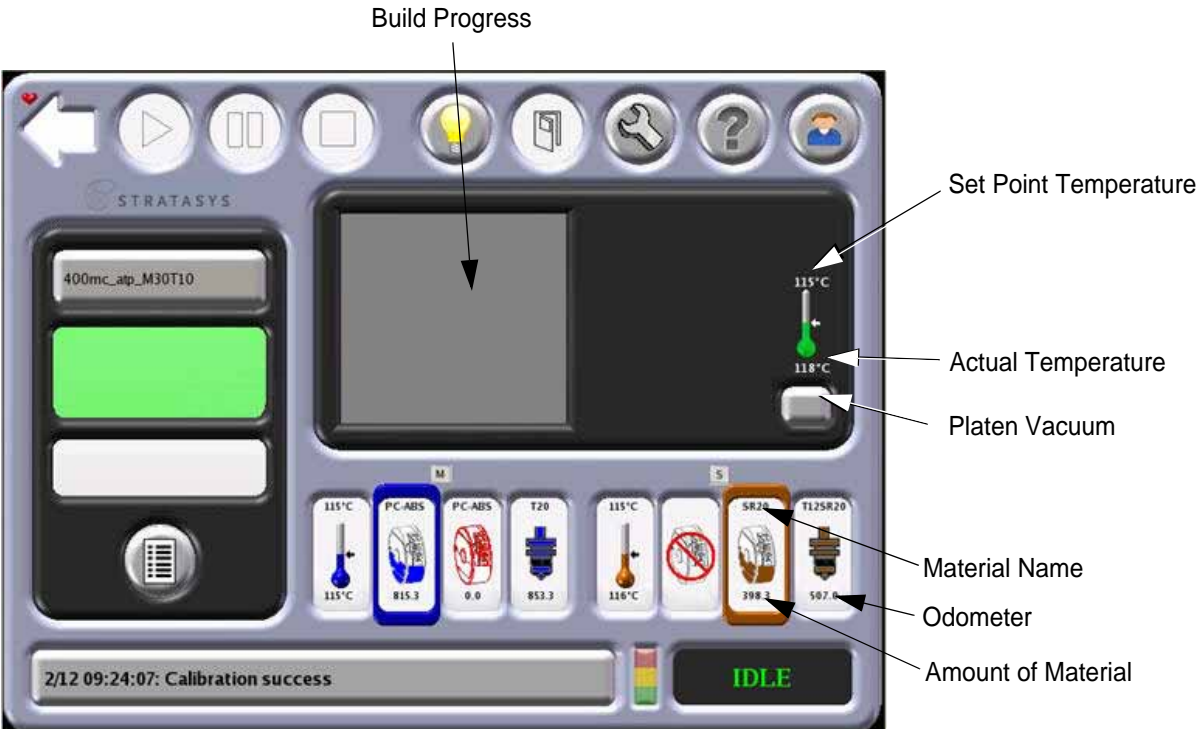

Platen Vacuum

Pressing the Platen Vacuum button turns off the platen vacuum so a build sheet can be removed. When off, the button displays a Ø symbol. Vacuum is restored by closing the oven door. The button is colored solid white to represent a lack of vacuum with a build sheet in place. A solid green color represents there is vacuum with a large build sheet in place. Green surrounded by white represents that vacuum is present with a small build sheet in place.

Figure 4-16: Platen Vacuum Icons

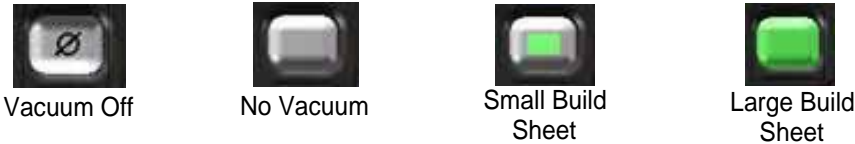

Health Monitor

Health monitoring software continuously checks the system which then alerts and records the health of the system. The monitored values are chosen for their relationship to system wear and performance.

Figure 4-17: Health Monitor Screen



The Health Monitor system determines which of the following four levels of health the Fortus 900mc system is experiencing. At any given time, each value is at one of these health levels.

- Good - All monitored values are within operational ranges.
- Acknowledged Warning - All monitored values are either in Good condition or their Warning has been acknowledged. (Warnings are acknowledged by checking the box next to the warning.)
- Warning - All monitored values are either in Good or Acknowledged Warning condition and one or more values are in a Warning condition.
- Error - All monitored values are either in Good, Acknowledged Warning, or Warning condition and one or more values are in an Error condition.



Alert Types

When a health level deviates from Good, an alert occurs. This alert causes the new health level to be logged and the status of the light pole to change.

The light pole reflects the overall state given by the Health Monitor.

Green: System is OK; it is building a part, or it is finished building a part.

Yellow: All monitored parameters are within tolerance.

Red: An indicator has moved beyond its control limit and is now outside of its specification limit. The system will not allow a part to start building. The system may pause, or stop, or power down depending on the condition.

Monitored Values

The following values are monitored by the Health Monitor system:

• UPS Input Voltage	• Support Tip Temperature
• UPS Output Voltage	• Machine state
• UPS Battery Voltage	• Inner Vacuum (build)
• Model Tip Plugs	• Outer Vacuum (build)
• Support Tip Plugs	• X Amp Status
• Oven Temperature	• Y Amp Status
• Model Tip Temperature	• Z Amp Status

Touchscreen Navigation

Building Screen

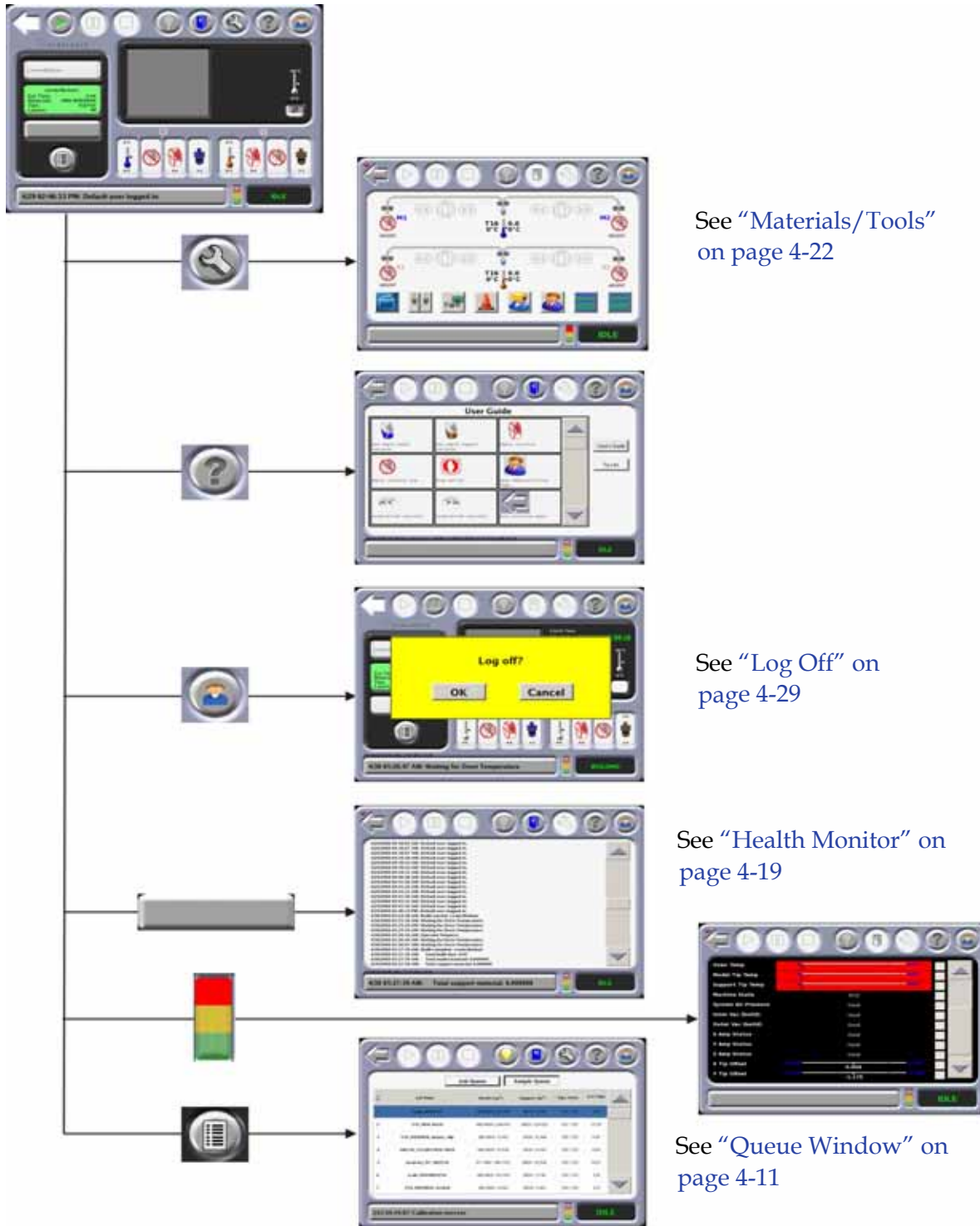

Materials/Tools

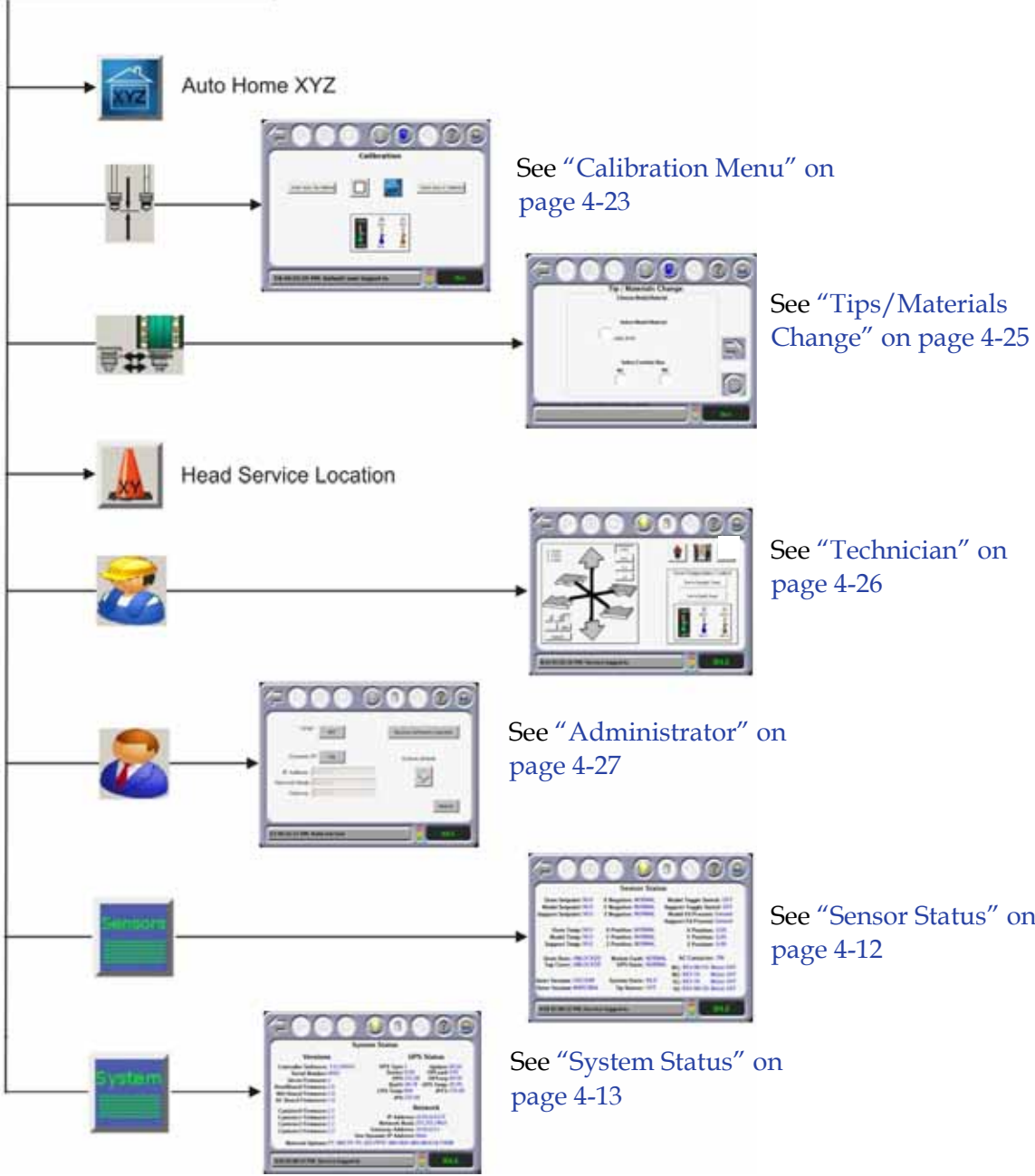



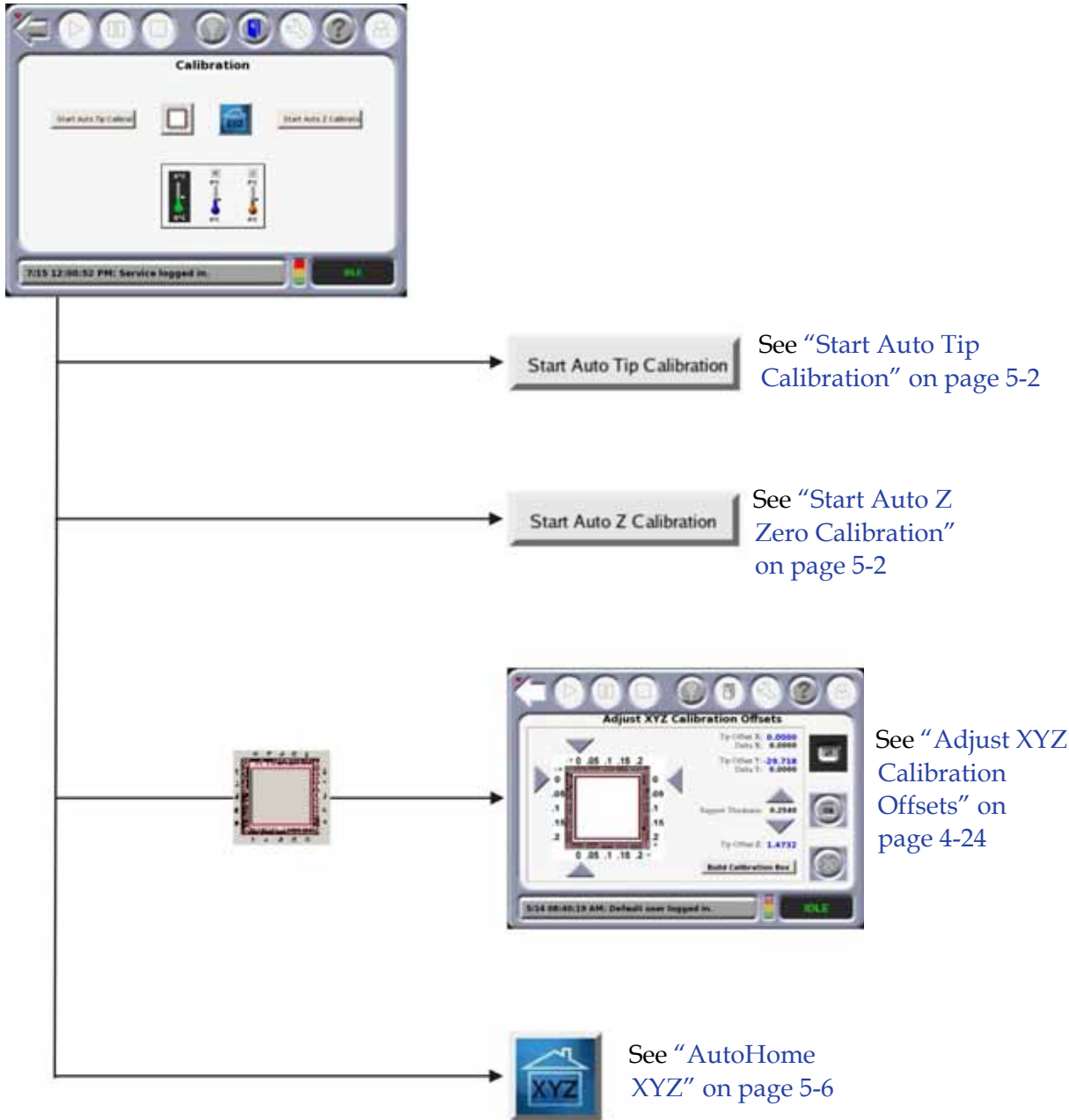

Calibration Menu

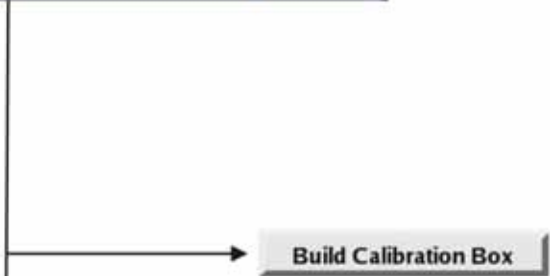

Adjust XYZ Calibration Offsets



-  Vacuum Off
-  Vacuum On (No Build Sheet)
-  Vacuum Good (Small Build Sheet)
-  Vacuum Good (Large Build Sheet)

Tips/Materials Change

i Screens may vary depending on tips and materials used.

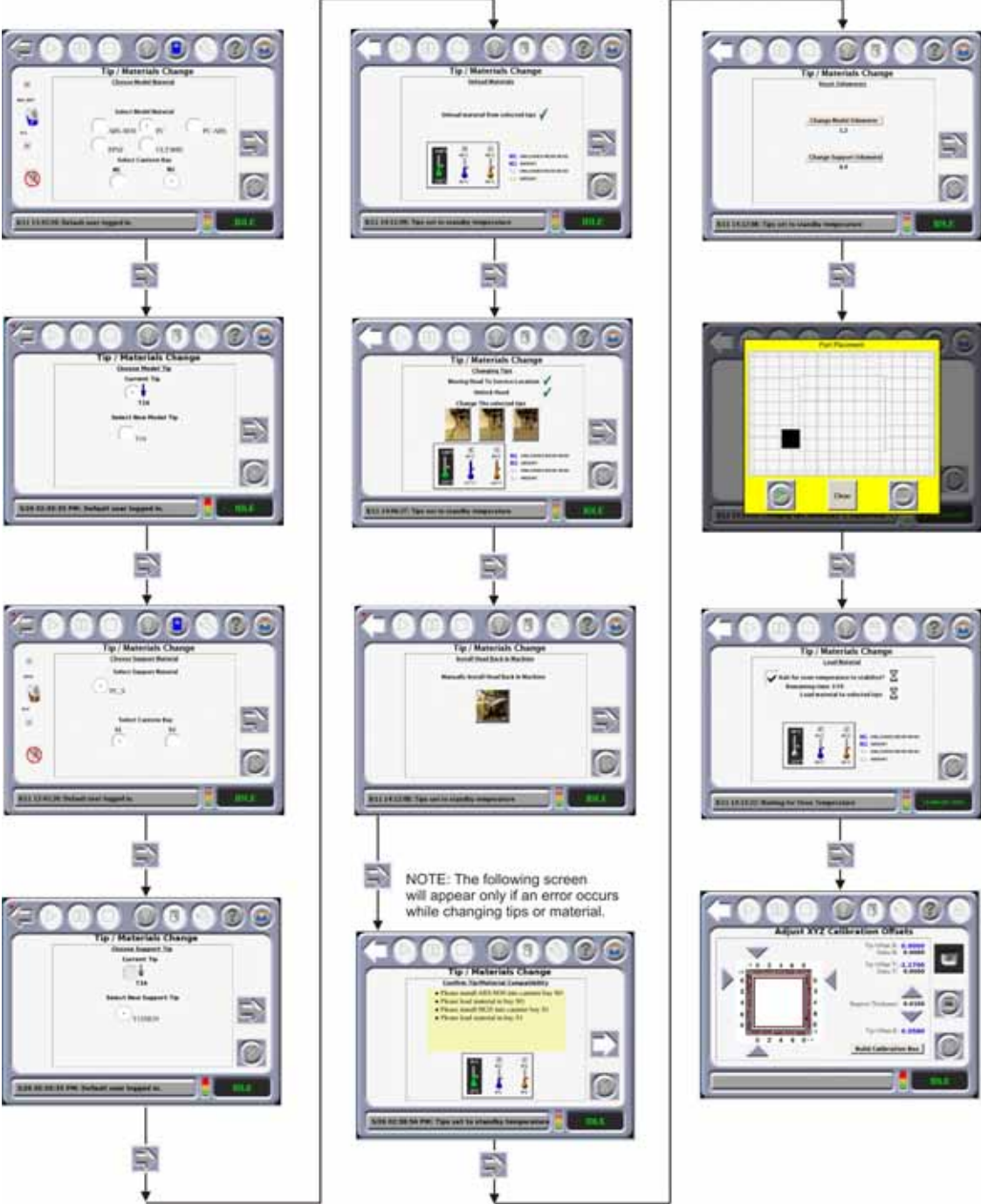

Technician

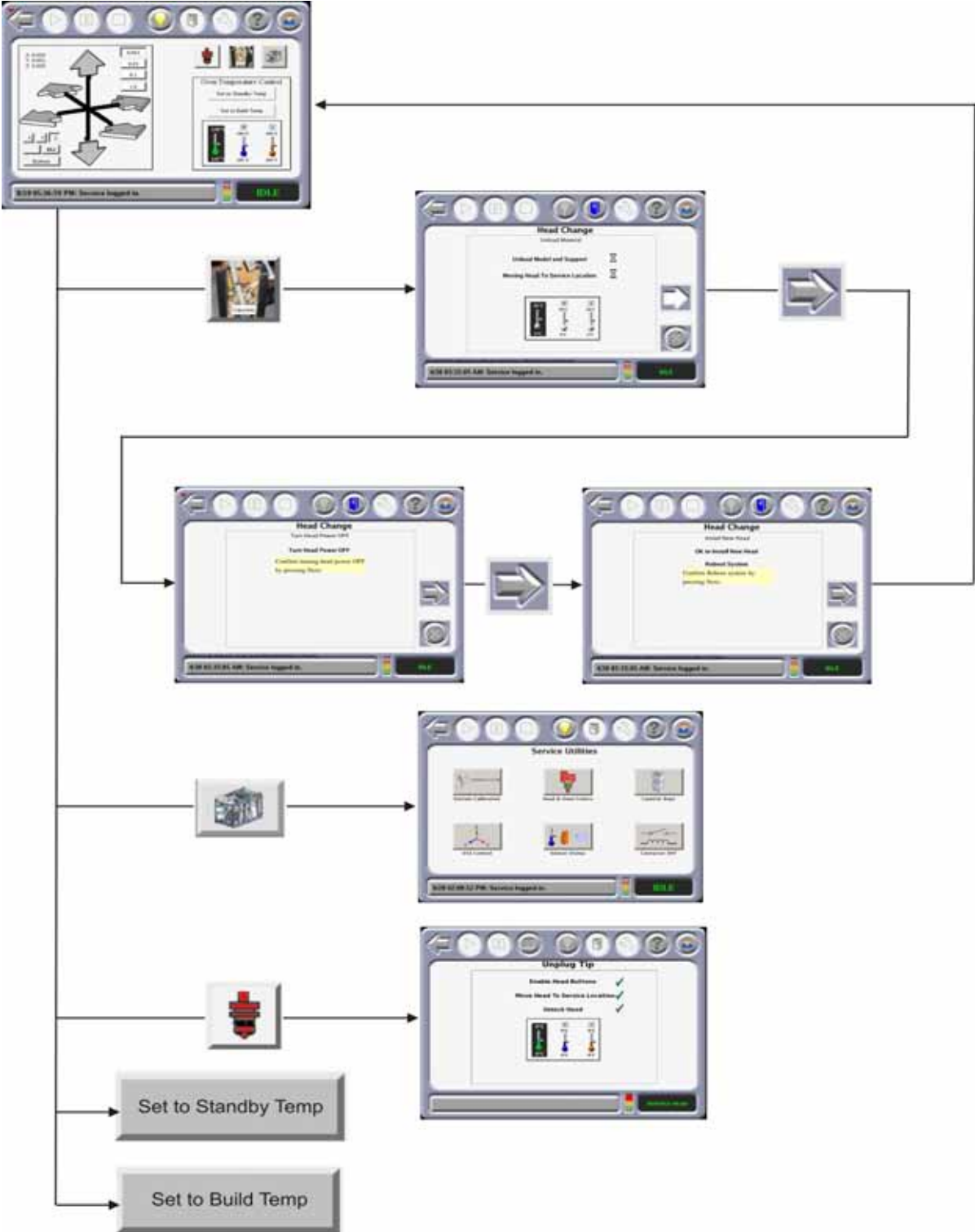

Administrator

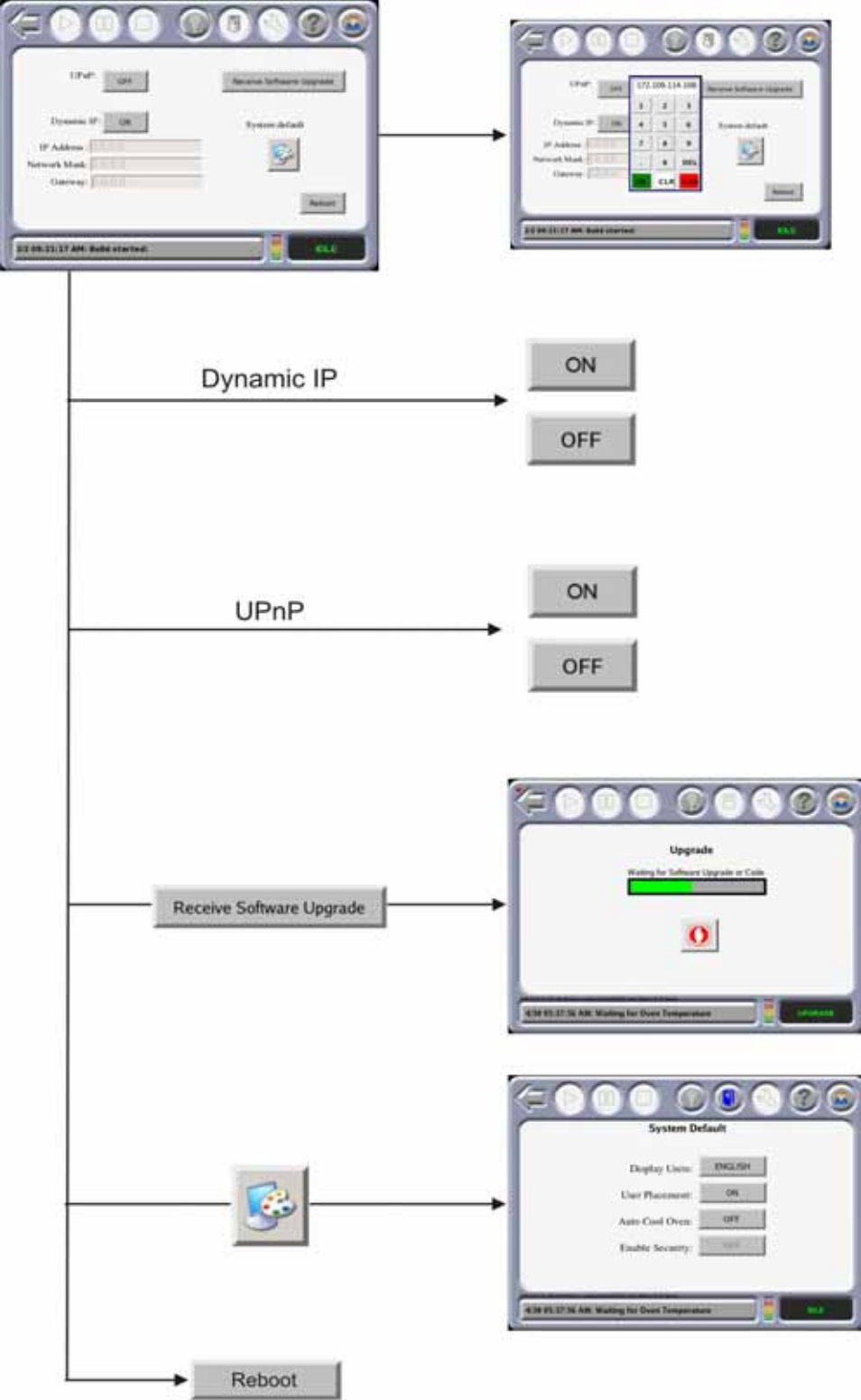

See "System Default" on page 4-28

System Default

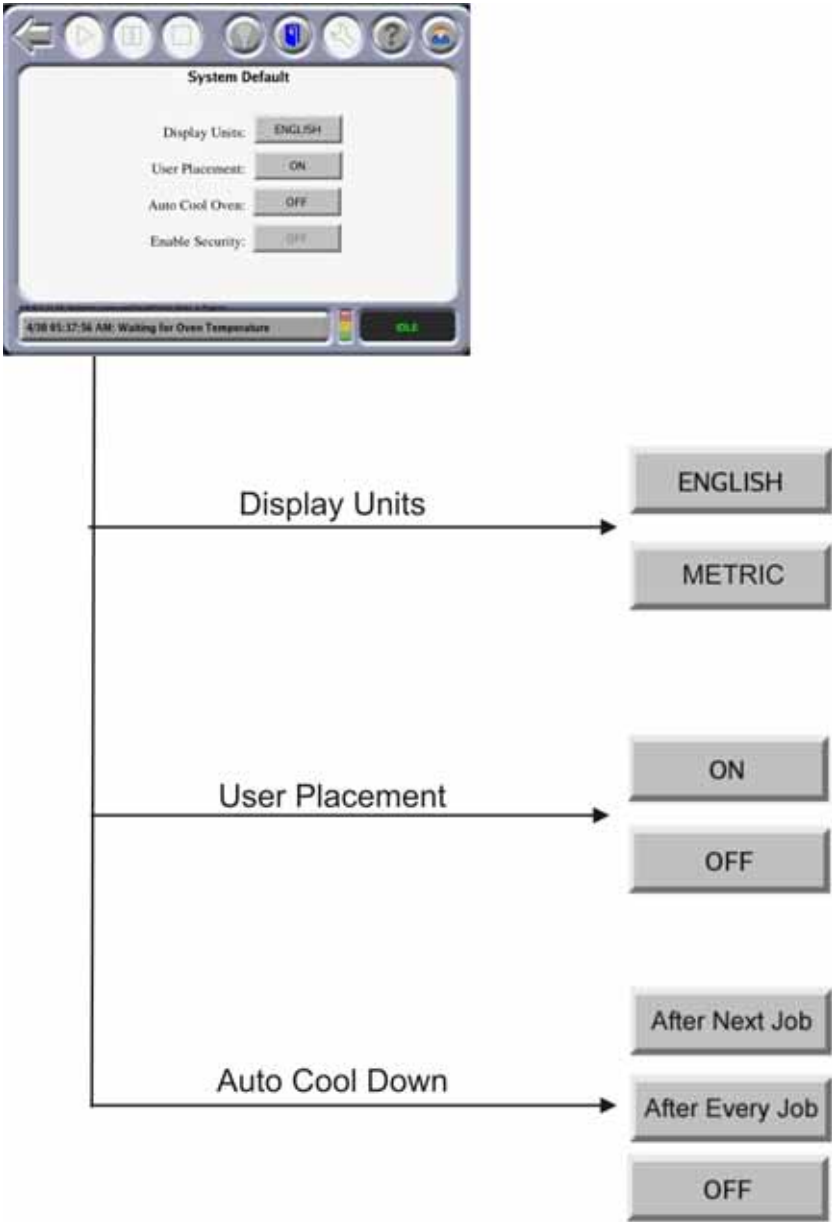

Log Off

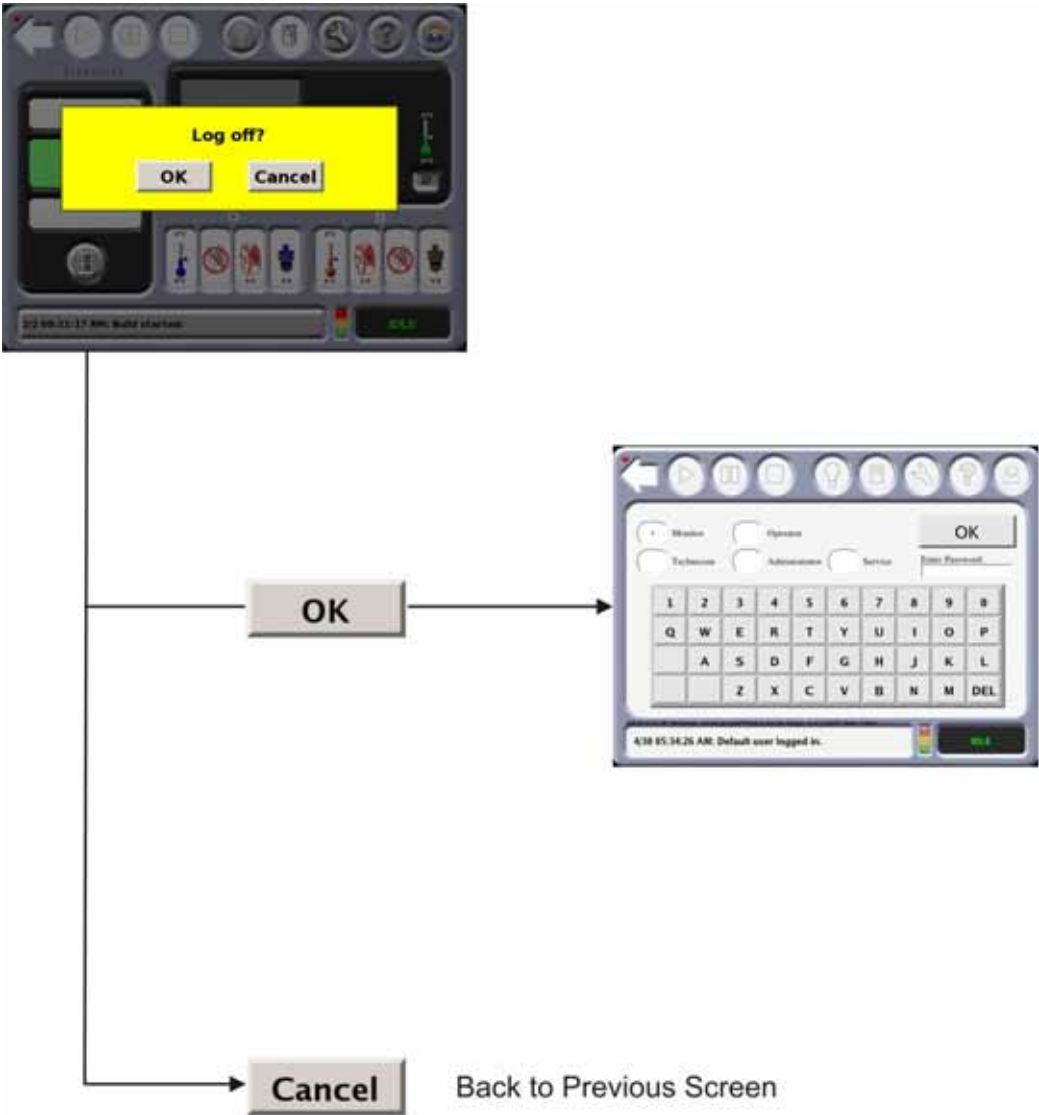

Queue Window



Job Queue

Displays all jobs waiting in the queue.

Sample Queue

Displays all sample jobs available.

Move Commands

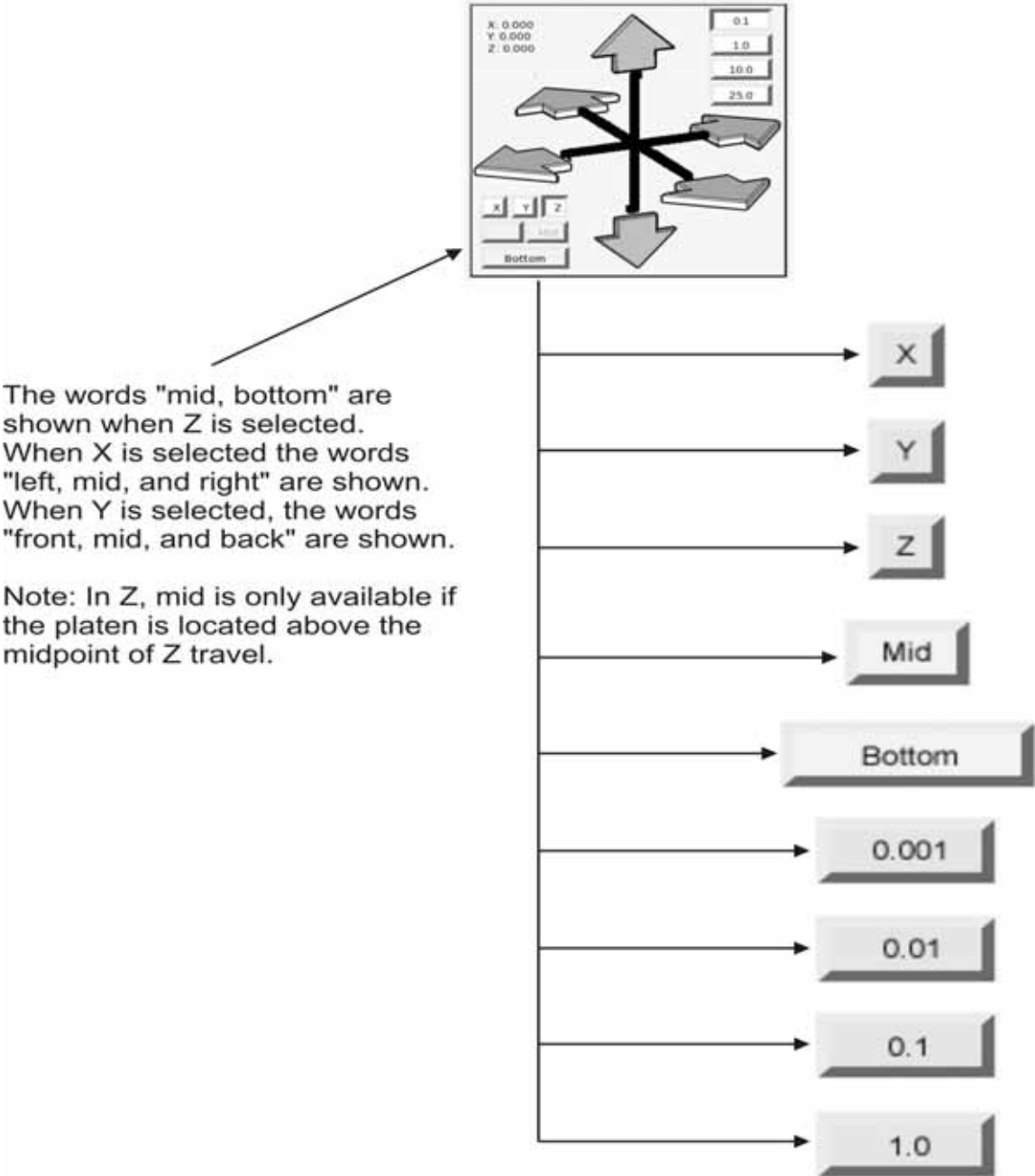

Powering On the System

1. Turn the system ON by pressing the flashing green button (Figure 4-1).
2. If there is a completed part in the system, remove the part from the system and install a new build sheet and close the door.
3. Press the **Materials/Tools** icon from the touchscreen and then press the **XYZ** icon to auto home the platen.
 - The system will find the home position for the X, Y, and Z axes. This must be done before any part can be built.
4. If the system has been powered down long enough for the oven to cool, allow the oven to heat and stabilize for at least four hours before performing system calibrations or part build.

Powering Off the System



Warning: Due to the UPS, high voltage is present in the system when the power cord is unplugged.



Caution: Do not turn the blowers off prior to the five minute time-out or damage to the system may occur.

To power down the system, press the red button (Figure 4-1).

- The oven lights go off.
- The screen will show: It is now safe to turn off your system.
- After a few minutes, the green light on the panel will flash.



If power to the system is removed, the head blower will continue to operate with power supplied from the UPS. The UPS will supply power for approximately five minutes while shutting down the system.

Always wait until the green button starts to flash indicating that the system is ready to be turned on again.

Basic Job Build Tasks

Before a Job Build

To build a job, you must send the job file to the system from the Insight application installed on your workstation. Jobs are sent in a CMB format and placed in the job queue (stored on the system hard drive). The header of the CMB file contains the processed job's basic information (material type, approximate material amount required for build, tip size, etc.). This information is used to verify job compatibility with the system setup.

For detail about how the system uses file information see [“SmartSpool System” on page 2-21](#).

1. Prepare the system:
 - A. Power up the system. (Stabilization of the system takes approximately four hours.)
 - B. Install a new build sheet by doing the following;



Warning: Wear proper safety equipment when handling items inside the oven. Surfaces in the build chamber can be very hot.

- a. Remove the plastic wrap from both sides of a new build sheet.



Always use a new build sheet when building a job. The build sheet is intended for one-time use. Do not turn a build sheet over and place it on the platen. Material residue on the sheet can adhere to the platen or interfere with the build sheet vacuum.

Using build sheets not provided by StratasyS may impact part quality and system reliability.

ABS, ASA and PC parts use a clear build sheet.

PPSF and Ultem parts use an amber-colored build sheet.

Nylon 12 parts use a green tinted build sheet.

- b. Set the build sheet on the platen.
 - The Fortus 900mc can accommodate two sizes of build sheets. Make sure the build sheet that is used is centered on the platen.
 - If the oven is hot, the build sheet will curl when placed on the platen. As the build sheet warms up, it will flatten and adhere to the platen. Some adjustment of the sheet may be necessary to seal it against the platen. (Turning the platen vacuum off and on will help this final adjustment to a warm build sheet.)
- c. Make sure the active model and support canister bays have filament loaded to the head (steady green LED).

- d. Make sure the loaded filament match the material requirements of the CMB file. Change material type if necessary (see “[Material, Canisters, and Liquefier Tips](#)” on page 4-43).
 - e. The touchscreen warns if there is a material mis-match.
 - f. Make sure that the tip cleaning brush and tips are clean.
 - g. Empty the purge bucket.
 - h. If using Auto-Cool Down, or if the material type has changed, allow the oven to heat and stabilize for at least four hours.
2. Modify System Defaults:
 - A. Display units - choose inches or metric. See “[Display Units](#)” on page 4-17 for more information.
 - B. User Placement on Platen - allows you to choose the part build location. See “[User Placement](#)” on page 4-17 for more information.

Select a Job to Build

From the Building screen, select one of the following job build options:

Figure 4-18: Selecting a Job

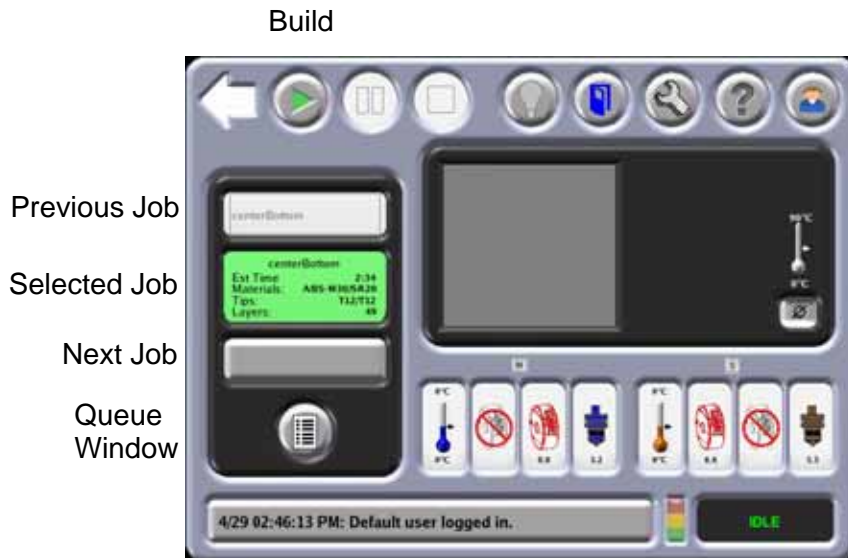

1. Next Job
 - Selects the first job in the job queue for build.
2. Previous Job - builds the last job completed.
 - The previous job built by the system will be selected for build.
 - If a previous job does not exist, the screen will show **No Previous Job**.

3. Queue Window
 - The job queue is displayed.
 - Select a specific job in the queue.
 - For more information on the Job Queue, see [“Working with the Job Queues”](#) on page 4-53.
4. If the User Placement option is set to on, the following screen will appear.

Figure 4-19: Positioning a Part

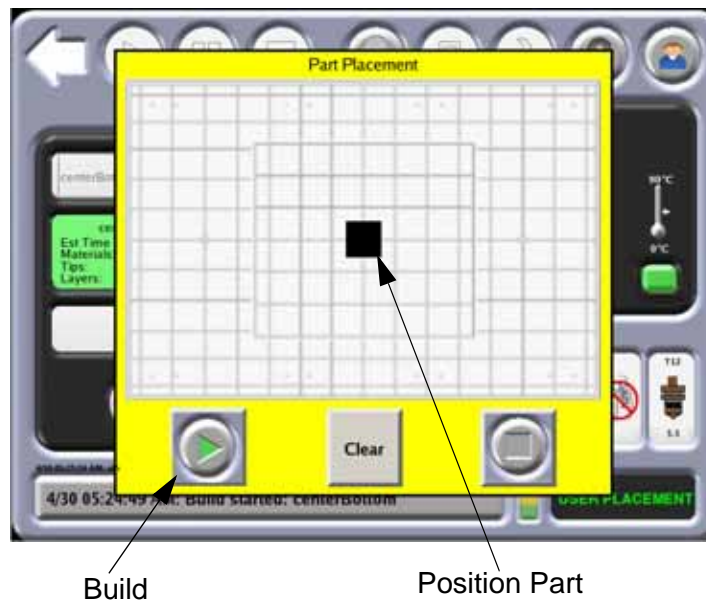

5. Using the touchscreen, position the part on the displayed platen.
6. Press the **Build** icon to initiate the building of the selected part.

Build Job Warnings

If the system detects an issue that may affect a job build, the system displays one of the following warnings:

Figure 4-20: Build Job Warnings



- A. Head has been changed. Consider tip calibration.
 - Indicates a new head has been installed.
 - Run and verify a calibration part before building jobs.
- B. Change Model (or Support) canister to ABS (or other material).
 - Indicates a mis-match between loaded material and material for which the part (CMB) file was processed.
 - Replace the flagged material canister with proper type.
- C. Need More Model (or Support) Material.
 - The total available material is less than the estimated amount for the part (CMB file).
 - If the system runs out of material before part completion, system will pause the build until material is added.
 - Replace flagged material canister.
- D. Need both (or 4 for 4-bay system) canisters present.
 - Indicates that at least one operating canister bay does not have material loaded to the Ready mode (flashing green LED)

- System operation will not be significantly compromised by this condition. The air-dryer circuit performs more efficiently when all operable bays are Ready.
 - Install canisters to the Ready mode for all operating canister bays.
- E. Replace Model (or Support) tip with T12.
- Indicates a mis-match between installed tip and tip for which the part (CMB) file was processed.
 - Install the correct.
- F. Replace Worn Model (or Support) tip.
- The system tracks the amount of material extruded through a tip. You will receive this prompt when tip performance may start to become compromised. (Tip-life prediction is an estimated value. Many factors contribute to actual tip-life aside from amount of material extruded. Actual tip-life may differ from predicted tip-life.)
 - Replace the flagged tip.
- G. Model / Support Material Incompatibility.
- Model and support materials are not of compatible types.
 - Load correct material.
- H. Vacuum not present. Check the build sheet
- Vacuum is below minimum for system operation.
 - Correct condition - often the result of a poorly positioned build sheet.
- I. Continue.
- You can choose to ignore the warning and 'Continue' the build, but part build quality will be unpredictable.



A warning generated from a mis-match of model/support compatibility or from low vacuum cannot be bypassed.

Information Available During a Build

The following information is displayed while building a job:

Figure 4-21: Job Information

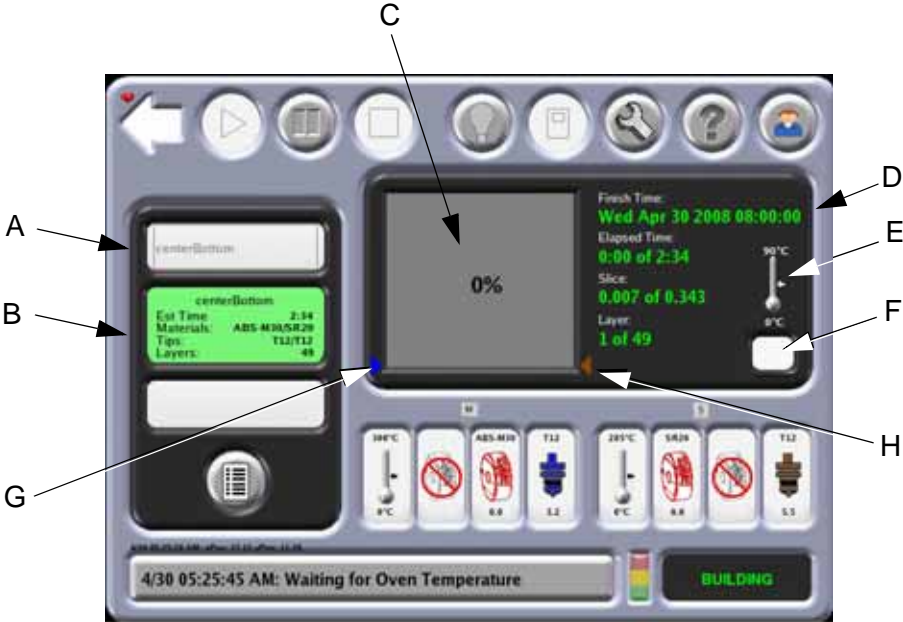

- A. The name of the previous job built.
- B. Estimated time to build the job, materials used, tips, and layers.
- C. Percentage of job completed.
- D. Finished time, elapsed time displayed in hours and minutes, slice and number of layers.
- E. Oven temperature.
- F. Presence of vacuum.
- G. Indicate the amount of model material that is available relevant to the current job. If there is enough material for the current build, the blue arrow will be at the top of the percentage completion window.
- H. Indicate the amount of support material that is available relevant to the current job. If there is enough material for the current build, the brown arrow will be at the top of the percentage completion window.

Pausing or Stopping a Job

1. During a part build, the system can be paused:
 - A. Automatically (canister runs out of material, failure detected, etc.)

 If an automatic pause occurs, the issue will appear in the System Log Button on the bottom of the screen.

 - B. Press the **Pause** icon on the Operator Touchscreen.
2. When the system is directed to pause, the following actions take place:
 - A. The current tool path is completed.
 - B. The Z Stage is lowered slightly.
 - C. The head is parked.
 - D. The user display will change to indicate the paused condition.
3. From the pause mode you can make the following selections:
 - A. **Resume Build** - the system resumes building the part.
 - B. **Modeler Status** - View the Job Status and Canister Status.
 - C. **Operator Control** - Unlock the oven door and top slide covers, clean tips, change materials (including load/unload and canister removal/installation), move the head, or move the Z Stage.
 - D. **Stop Job** - Stops the current job.

Figure 4-22: Pause Mode



After a Job Build



Warning: Wear proper safety equipment when handling items inside the oven. Surfaces in the build chamber can be very hot.

1. The system performs the following actions:
 - A. The Z Stage is lowered and the head is parked.
 - B. The touchscreen will display the following Build Complete message:

Figure 4-23: Build Complete



2. Press **OK** and then remove the part from the system.



If Auto Cool Oven is active, allow the oven to cool to the standby temperature before removing the part.

- A. Turn off the vacuum with the button on the touchscreen.
- B. Open the oven door.



Caution: Do not attempt to remove a part from the build sheet while the build sheet is on the platen. Damage to the platen or the platen level may occur.

- C. Remove the build sheet from the platen.



Caution: Use extreme care when cleaning the platen. If using a brush, brush away from the vacuum port in the center of the platform. If debris falls into the vacuum port, it can cause a loss of vacuum, resulting in poor adhesion of the build sheet during building.

- D. Use a vacuum cleaner or a soft brush to remove debris that may have fallen onto the platen.
3. Carefully peel the part from the build sheet.
 - If the part does not peel easily, use the metal scraper included in your Startup Kit to carefully pry the part from the sheet.
 - The build sheet is intended for one-time use. Do not turn a build sheet over and place it on the platen. Material residue on the sheet can adhere to the platen or interfere with the build sheet vacuum.
4. Remove supports from the completed part.

Removing Supports

Breakaway Support Material

PC material uses break-away supports, called BASS. This material must be removed manually.



Warning: Wear safety goggles and leather gloves (provided in Startup Kit) when removing breakaway supports.

Remove the support material carefully. The material should break away with relative ease. If necessary, use needle nose pliers, probes, knife, or a pick to remove the supports. Use special care for sections of the part that are fragile or thin.

Soluble Release Support Material

Soluble Release support material is used with ABS-M30, ABS-ESD7, ASA and PC-ABS material. After building a part, you can remove supports by using an Ultrasonic or Circulation tank containing a solution of water and WaterWorks soluble solution.

For more information on WaterWorks, refer to the WaterWorks User Guide located on Stratasys' Customer Extranet.

Support Material for PPSF Parts

Removing supports from PPSF parts requires a slightly different support removal process than with ABS, ASA or PC, which uses BASS supports. With PPSF, the interface layer of the support (the layer that contacts the part) can be pulled or removed from the part easier if the part is hot; the heat makes it flexible and less brittle.



Remove the part from the PPSF build sheet as soon as possible after removing it from the oven.

Remove the supports immediately after the part is built. If you can't remove the supports immediately, reheat the part to between 160° C and 220° C (320° F to 428° F). You can use the modeler oven, or another oven that can reach the necessary temperatures, to reheat the part.



Removing supports from two or more parts at a time is most efficient when reheating parts. You can remove supports from one part while the others are heating up.

The difficulty of support removal is based on the following: part size, amount of supports, support style, and support temperature. Stratasys recommends removing the supports in the following order:

1. Base
2. Structures
3. Thin horizontal sections
4. Around small features
5. Angle support faces
6. Large mass sections

Material, Canisters, and Liquefier Tips

Unloading Material from the Liquefier Tips

 If you are changing to a different material type or changing tips, follow the procedure outlined in “Changing Tips or Material Type” on page 4-50.

Unloading filament from the liquefiers is done in the Idle mode only, not while building or in a paused state.

1. Make sure the system is in the Pause or Idle mode.
2. From the Main Menu, select **Operator Tools** and the following screen will appear.

Figure 4-24: Operator Tools

Unload

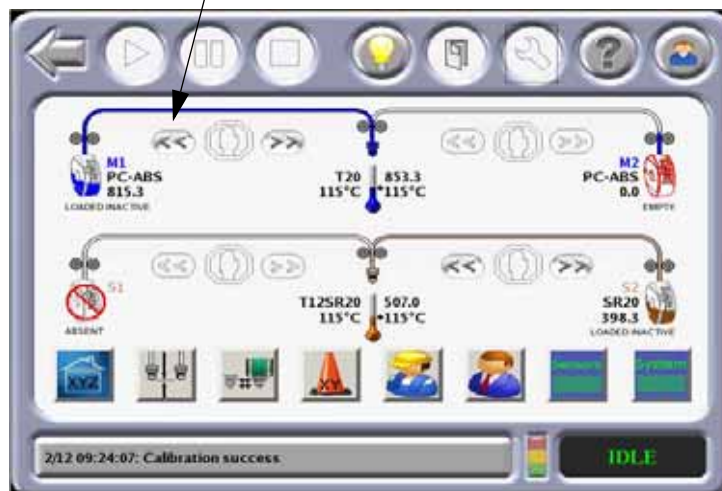

3. Select the material to be unloaded and press the **Unload** icon.
 - A. The head warms up to the unload temperature, and the canister LED rapidly flashes green.
 - B. The head drive motors and canister drive motor turn in reverse. The material is pulled back from the head about 4-6 inches (10-15 cm).

 For some materials (i.e., SR-20), a tip purge is performed before the material is unloaded from the liquefier.

- C. The head temperature lowers to standby temperature and the canister LED turns to a slower flashing green (same flash rate as used to indicate canister Ready condition).
- D. The display will show **At Head** for the unloaded material.

4. Replace the canister. Refer to “Removing Canisters” on page 4-44, “Canister Installation” on page 4-45, and “Handling/Storing Canisters” on page 4-49.

Removing Canisters

1. Removing an empty canister:
 - A. Raise the drive block off the canister by lifting the drive block lever.
 - B. Pull the canister out of the bay.



Empty canisters have a small, unusable volume of material remaining. The leftover material allows manufacturing tolerances and ensures that Auto Changeover works properly.

- There will be a piece of material, approximately 2 inches (5.1 cm) in length, that extends beyond the filament exit hole. When removing an SR-20 support canister, this piece may break off when the canister is removed. Make sure that the broken piece drops out of the drive block. If necessary, remove the drive block inlet to remove this piece of material.

2. Removing a partially used canister:

Refer to [Figure 4-25 on page 4-46](#) for referenced item numbers.

- A. Unload filament from the liquefiers (see “Unloading Material from the Liquefier Tips” on page 4-43).
- B. After **Unload Complete** is displayed on the user panel, open the canister thumbwheel door (item 3).
- C. Re-insert the square foam gasket (item 7A) into the thumbwheel door.
- D. Close the thumbwheel door.
- E. Raise the drive block off the canister by lifting the drive block lever.



Caution: Immediately pull the canister from the bay after lifting the drive block lever. A delay may allow filament to be forced into the canister. If filament is forced into canister, cross winding is likely, making the entire canister unusable.

- F. Immediately pull the canister out of the bay (within ten seconds of lifting the drive block lever).
 - a. When the drive block lever is raised, the drive block motor runs in reverse and pulls material from the system.



Caution: Discard material pulled from system. Do not attempt to rewind material in canister. If filament is forced into canister, cross winding is likely, making the entire canister unusable.

- b. The excess material accumulates in the empty drive bay.
- c. As the end of the filament exits the filament present switch, the canister-drive motor stops.
- G. Cut the filament flush with the top of the canister snout.
- H. Remove the plastic plug from its storage location (item 6B) and insert it into the filament outlet hole of the canister snout (item 4 and 6A).
- I. Pull remaining filament from the drive block and discard all accumulated material in the drive bay.
- J. To Install a Canister see [“Canister Installation” on page 4-45](#).

Canister Installation

1. Install the canister (refer to [Figure 4-25 on page 4-46](#) for referenced item numbers).
 - A. For new canisters, peel back the foil tape (item 1) on the side of the canister.
 - B. Remove and discard the anti-rotation plug (item 2).
 - C. Reseal the canister hole with the reusable foil tape by pressing it firmly against the canister to establish an airtight seal
 - D. Pick up the canister by grasping the plastic snout (item 4).
 - E. Rest the canister on the edge of the bay - do not push the canister fully into the bay.



Caution: Do not remove the plastic cap until you are ready to preload the filament into the drive block.

- F. Remove the plastic plug (6A) on top of the snout.
- G. Snap the plastic plug into the storage slot (6B).
- H. For new canisters, prepare the filament (5) for loading:
 - a. Open the thumbwheel (3) door on the front of the canister.
 - b. Cut the filament below its bend so that the filament end is flush with the top filament outlet of the snout.
 - c. Close the thumbwheel door (do not remove foam center from gasket yet).
- I. Push canister all the way into the canister bay.

Figure 4-25: Canister Installation

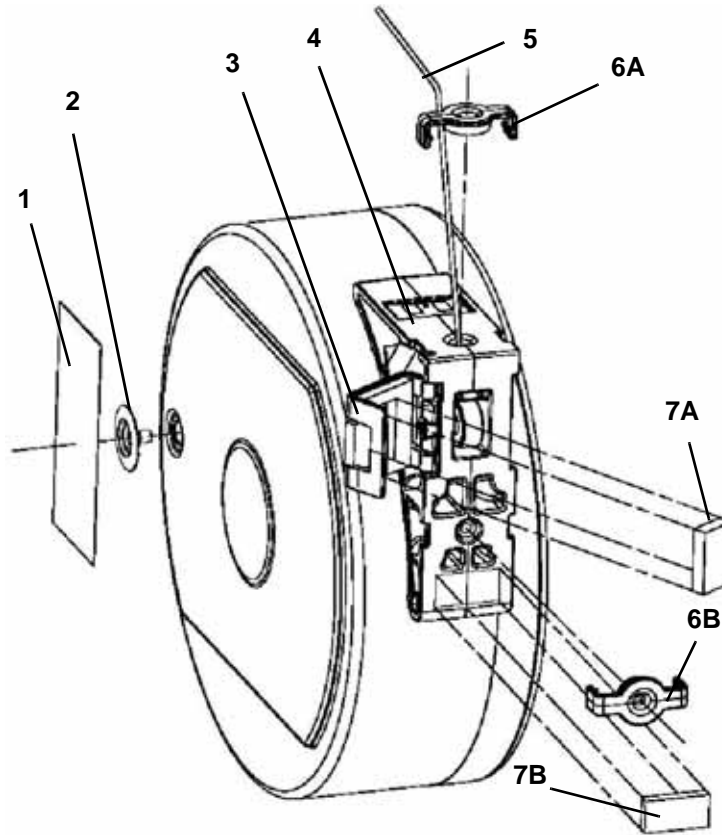

Item	Description	Item	Description
1	Foil Tape	6A	Plastic Plug (sealing position)
2	Anti-Rotation Plug	6B	Plastic Plug (stowed position)
3	Thumbwheel Door	7A	Foam Gasket (sealing position)
4	Canister Snout	7B	Foam Gasket (stowed position)
5	Filament		

- J. Drop the filament drive block down onto the canister by pulling out the canister drive lever. (Figure 4-26)
- Verify that the filament drive is aligned with the filament exit.
 - The LED is OFF at this point.
 - After about five seconds, the SmartSpool chip is read by the system and the drive block motor starts turning.
- K. Perform “Preload filament to the drive wheels:” on page 4-47.

Figure 4-26: Preloading Filament

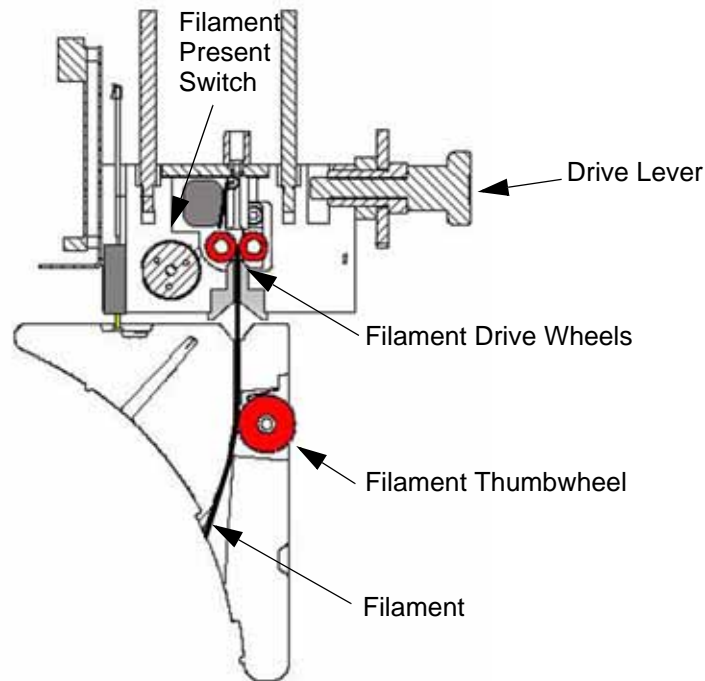

2. Preload filament to the drive wheels:
 - A. Open the thumbwheel door.
 - B. Remove the square foam gasket on the inside of the thumbwheel door. (Figure 4-25)
 - C. Stick the gasket onto the canister.
 - The square foam gasket prevents the thumbwheel from moving.
 - The gasket must only be removed when the canister is in the system.
 - The gasket is re-used if the canister is to be stored.
 - D. Feed the filament into the filament drive mechanism by pressing in and down on the thumbwheel. (Figure 4-26)
 - E. Turn the wheel until you feel the filament drive motor pull the filament.
 - The filament needs to be advanced approximately 2 inches (5 cm) to reach the drive motor drive wheels.
 - F. The system automatically completes the preloading of the filament.
 - The drive motor advances the filament until it contacts the filament present switch.

- The drive motor stops, and the LED turns to green flashing.



Caution: Make sure that the thumbwheel door is closed after filament preload is accomplished.

- G. Close the thumbwheel door.
- H. Load material to the head (see “Loading Material to the Liquefier Tips” on page 4-48).

Loading Material to the Liquefier Tips



If you are changing to a different material type or changing tips, follow the procedure outlined in “Changing Tips or Material Type” on page 4-50.

Loading filament to the liquefiers is done in the Idle or Paused mode only, not while building.



Caution: If the material type is changed, the tips must be changed.

1. Make sure the system is in the Pause or Idle mode.
2. From the Main Menu, select **Operator Tools** and the following screen will appear.

Figure 4-27: Operator Tools

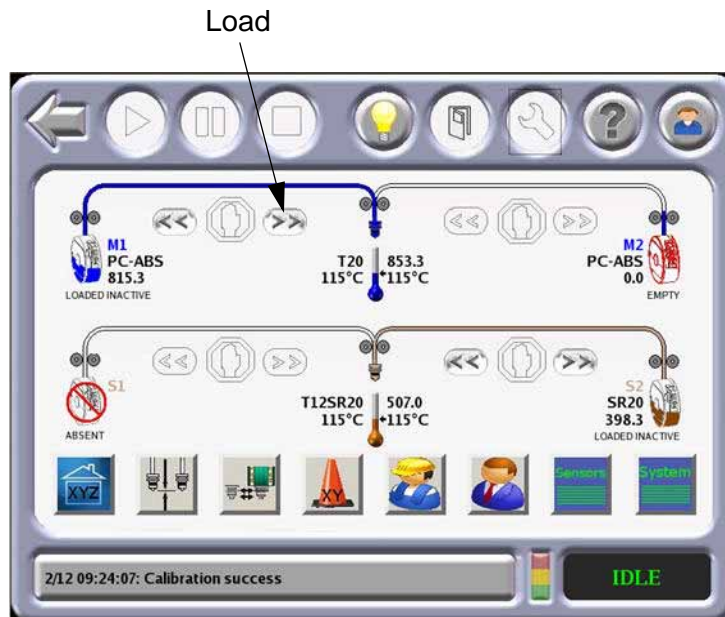

3. Select the material to be loaded and press the **Load** icon.



Model and support materials must be compatible. If a selected material is incompatible with a loaded material, a material mis-match load error will occur. The selected material will not be loaded.

- A. The head warms up to the material operating temperature (Automatic - based on SmartSpool data). This step also sets the oven temperature to the correct value for the material being loaded.
- B. The canister drive motor starts to push the filament to the liquefier tips.
- C. For some materials (i.e., SR-20) the order of steps A and B is reversed.
- D. When the filament reaches the head (takes 2 to 4 minutes), it enters the liquefier tip, and the tip purges a small amount of material.
- E. A successful load is indicated by a steady green LED. A complete load and purge cycle should take less than five minutes.

Canister Auto Changeover

1. Auto Changeover allows you to leave a long part build unattended.
2. When an active canister becomes empty:
 - A. The system is paused and the canister drive automatically withdraws residual material from the system.
 - B. Material is then loaded to the head from the full canister.



If the material to be loaded is not the same as the material it is replacing the auto changeover will not occur and the system will enter the **Pause** mode.

3. If an error occurs during the Auto Changeover process, the system will remain paused.
 - The System Log Button will show the cause of the error.
 - Once the error is resolved, select **Resume** on the Operator Touchscreen to continue building the job.

Handling/Storing Canisters



Caution: How material canisters are handled and stored has a direct impact on part build quality. Like most engineering plastics, the filament within the canisters can absorb moisture. Filament moisture causes poor model surface quality.

1. Each canister holds 92 cubic inches (1510 cc) of filament material. The canister also contains desiccant material to absorb moisture.

2. A removable plastic cap and a thumbwheel door provide an airtight seal to keep moisture from entering the canister while stored.



Caution: Make sure that you insert the square foam gasket under the thumbwheel door and place the plastic cap over the filament outlet hole when storing a canister. In less than one hour, in an unsealed canister, filament can absorb enough moisture to become unusable.

3. If a canister containing material is removed from the system, or remains in the system in a non-ready state (LED is OFF), it should be stored as follows (refer to [Figure 4-25](#) for referenced item numbers):



When the filament is in a ready or loaded state (flashing green LED or steady green LED), and the canister door is closed, the system air-dryer system constantly purges moisture from the canister.

- A. Open the thumbwheel door (item 3) and insert the square foam gasket (item 7A) (stored on the canister - item 7B) into its thumbwheel door location.
- B. Close the thumbwheel door - make sure that it is completely closed.
- C. Remove the plastic cap from its stowed position (item 6B) and insert it into the filament outlet hole of the canister snout (item 4 and 6A).
- D. Store canisters in an upright position, do not lay them flat.

Changing Tips or Material Type



If you are changing tips, or changing to a different material type, the user interface has a menu selection that guides you through the process.



Caution: If the material type is changed, the tips must be changed.

1. Clean the oven and the tip wipe assembly.
2. Empty waste material from the purge bucket.



Residue from lower temperature materials can melt and drip onto higher temperature parts if cleaning is neglected.

3. Inspect the tip wipe assembly (refer to “[Clean/Inspect Tip Wipe Assembly](#)” on page 6-8).
4. From the Main Menu select the **Materials/Tools** icon and then select the **Tips/ Materials Change** icon.

Figure 4-28: Operator Tools

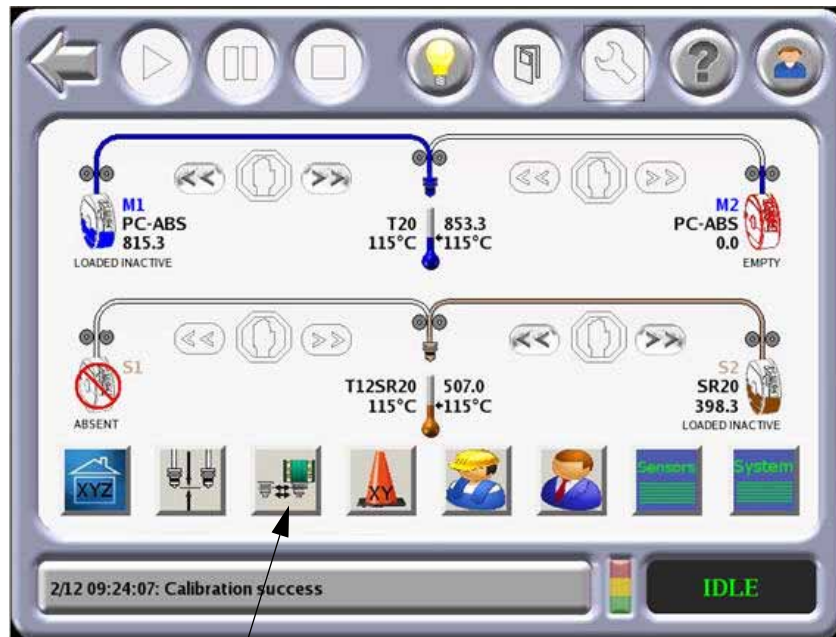

Tips/Materials Change

5. The Tips/Materials Change menu is designed to guide you through the steps necessary to complete a material type change or a tip replacement procedure.
6. If the liquefier tips are to be changed:



Warning: Always use an approved ladder or step stool when working with components under the top slide covers.

- A. Open the top slide covers.
- B. Place the head in the head maintenance bracket (refer to “Head Maintenance Bracket” on page 2-7).



Warning: Surfaces of the liquefier tips and heater block can be very hot.

- C. Loosen the two captive screws that clamp each liquefier tip in place. Remove the tips.

Figure 4-29: Liquefier Retaining Screws

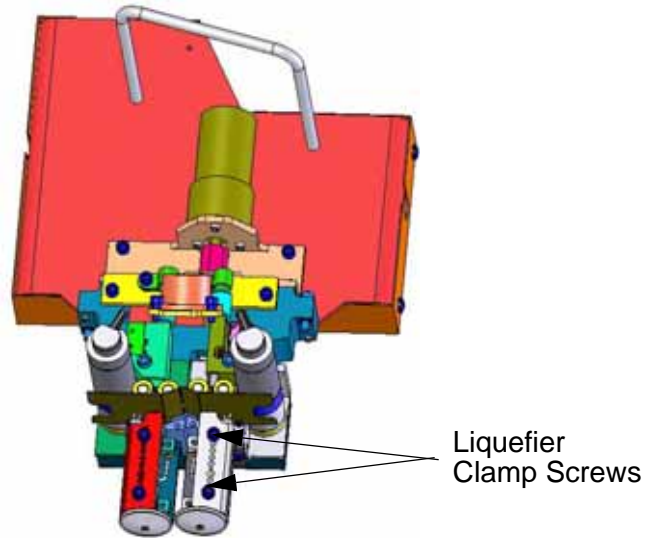

D. Place the new liquefier tips in the head. Tighten the clamp screws.



Make sure the tips are fully inserted into heater block before tightening the clamp screws (Figure 4-30).

- See “Liquefier Tips and Slice Heights” on page 2-11 for tip selection and material compatibility.

Figure 4-30: Tip Installation

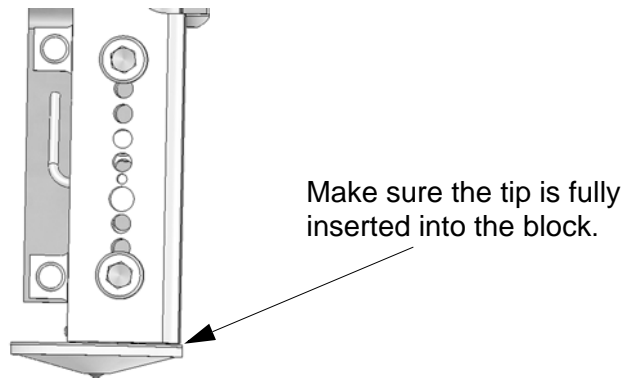

E. Remove the head from the maintenance bracket and place it back in the gantry. Tighten the two captive screws that hold the head in place.



Make sure the filament tubes, umbilical cable, and air hose are not tangled and are routed correctly.

Working with the Job Queues

1. There are two job queues available on the Fortus 900mc - the Job Queue and the Sample Job Queue.

Figure 4-31: Job Queues

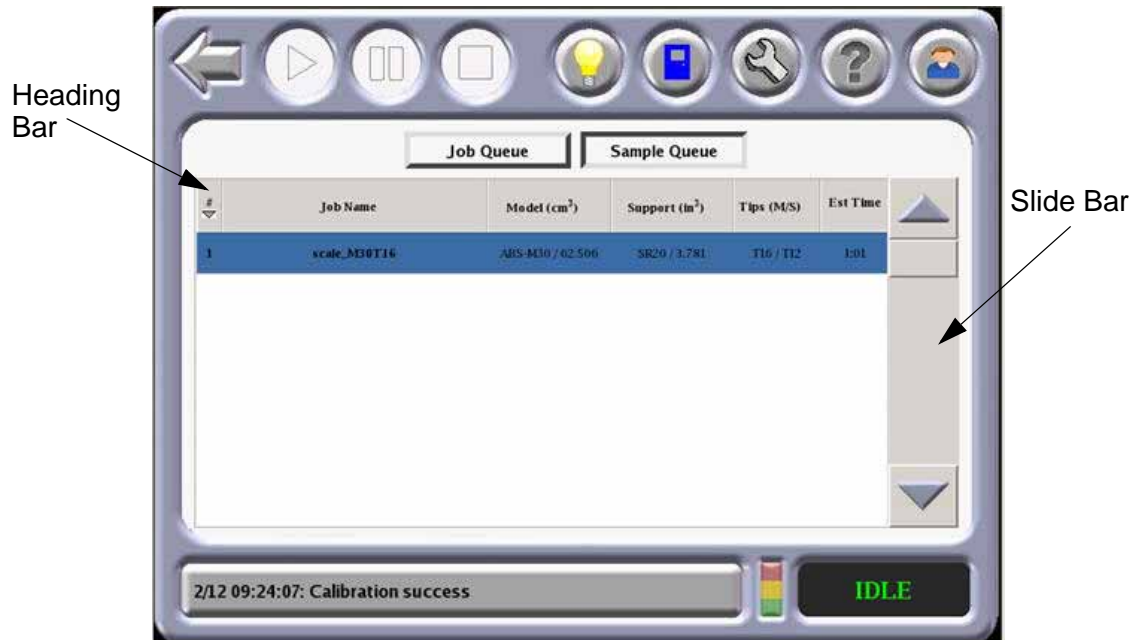

2. Select either Job Queue or Sample Queue.
 - A. The Job Queue menu - contains files downloaded from the Insight application on your PC workstation.
 - Side Bar - Use the slide bar to scroll the display up or down through the available jobs.
 - Heading Bar - Press any column in the heading bar to change the order of the column listing.
 - B. The Sample Job Queue menu - contains files that are helpful for testing the system. The Fortus 900mc comes with several sample job files permanently installed on the system.
 - Use the slide bar to scroll the display up or down through the available sample jobs.

System Status

The System Status screen displays the following information:

- System Software Versions
- UPS Status
- Network Setting

Figure 4-32: System Status

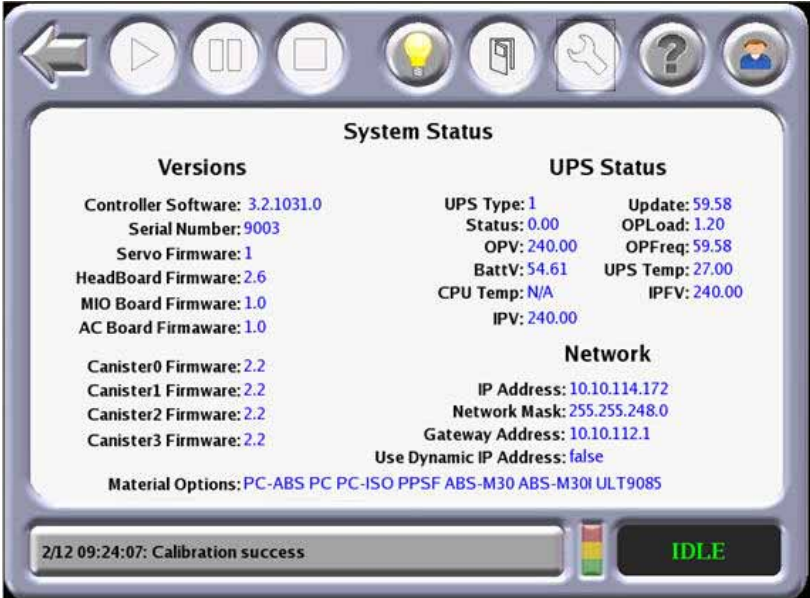

Chapter 5: Calibration

5

This chapter describes basic calibration procedure of the Fortus 900mc system.

Automatic Calibration

After tips are changed the user menu will prompt you to perform a series of automatic calibrations: Autocal Tips Calibration, Autohome XYZ, and Auto Z Calibration.

Figure 5-1: Calibration Menu



Perform an Autohome XYZ before initiating automatic calibration.

Operator interaction is not required for Auto Z Stage Zero calibration.

XY and Z Tip Offset requires that the operator analyze a calibration part and supply the system with correction values.

Start Auto Z Zero Calibration

Start Auto Z Zero Calibration sets the model liquefier tip to the Z zero location on the build sheet.

No operator interaction is required. This is also performed automatically before each job build.

Start Auto Tip Calibration

Start Auto Tip Calibration allows the user to calibrate the tip-to-tip offsets in the Z direction. No operator interaction is required.

1. The system automatically performs this calibration as part of the tip change wizard actions.
2. Proper calibration allows the system to toggle material tips and place the current tip at the precise coordinate necessary to continue accurate part build.

Adjust XYZ Calibration Offsets

Adjust XYZ Calibration registers the support tip relative to the model tip.

Figure 5-2: Adjust XYZ Calibration Offsets

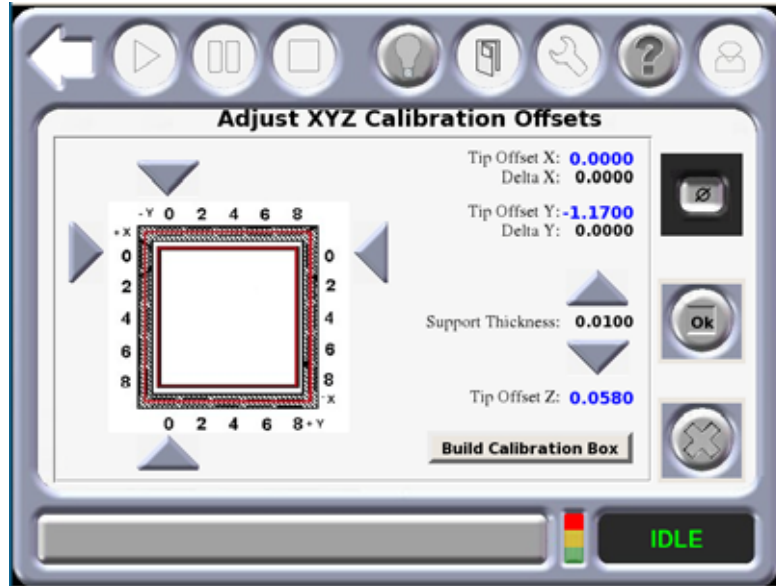

1. The system automatically builds the calibration model when the Build Calibration Box button is pressed.
2. Remove the build sheet from the platen and allow it to cool.
3. Determine the XY Offset Adjustment ([Figure 5-3 on page 5-4](#) or [Figure 5-4 on page 5-5](#))
 - A. View the relationship between the support calibration toolpath and the alignment indicators to determine the X and Y Axis calibration.
 - Use a magnifier.
 - Hold the build sheet up to the light, a light-colored wall, or a light-colored piece of paper.
 - B. Determine where on each axis the support toolpath is most centered between the X-Y alignment path.
 - C. Read the Offset Adjustment Value closest to the centered location for each location.
 - This value represents the adjustment value to be entered into the system - increments of 0.002 of an inch or 0.05 mm.
 - If the value is 0, then the system is calibrated for that axis - an entry is not required.

- D. Slide the arrow on the screen to match where the support is most centered. Only move arrows on two of the four sides of the calibration part.
- E. Press **OK**. The screen will pop up asking if you want to apply these values. Press **OK**. When X and Y are both at 0, proceed to adjusting the Z.
- F. If an adjustment entry for either axis is required, re-run the calibration model on a clean build sheet.
- G. Continue to check and adjust for XY offset until the calibration toolpath is centered at 0 for the X and Y axis.

Figure 5-3: Calibration Model - English Units

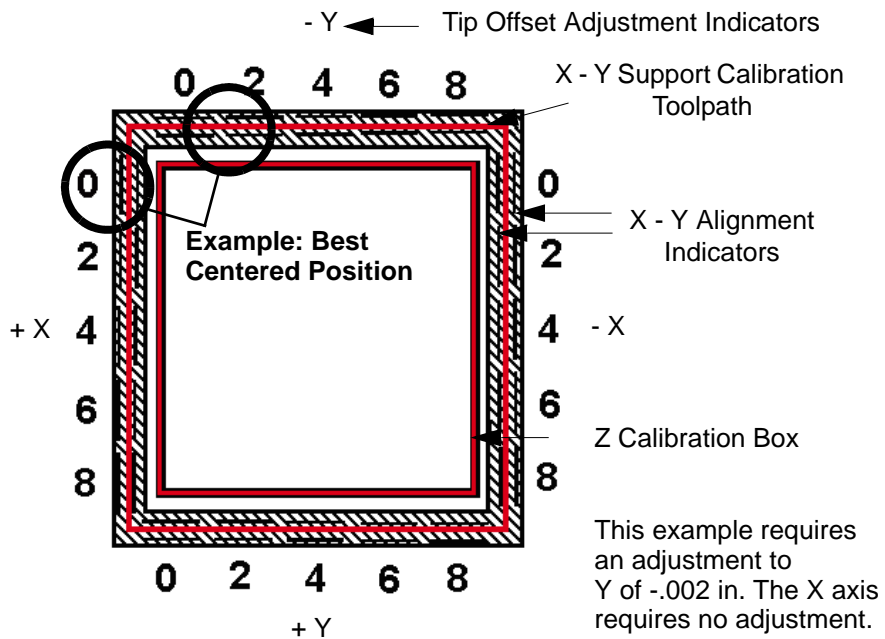

- H. After the adjustments are made, a new calibration box can be run from this menu by pressing **Build Calibration Box**.

Figure 5-4: Calibration Model - Metric Units

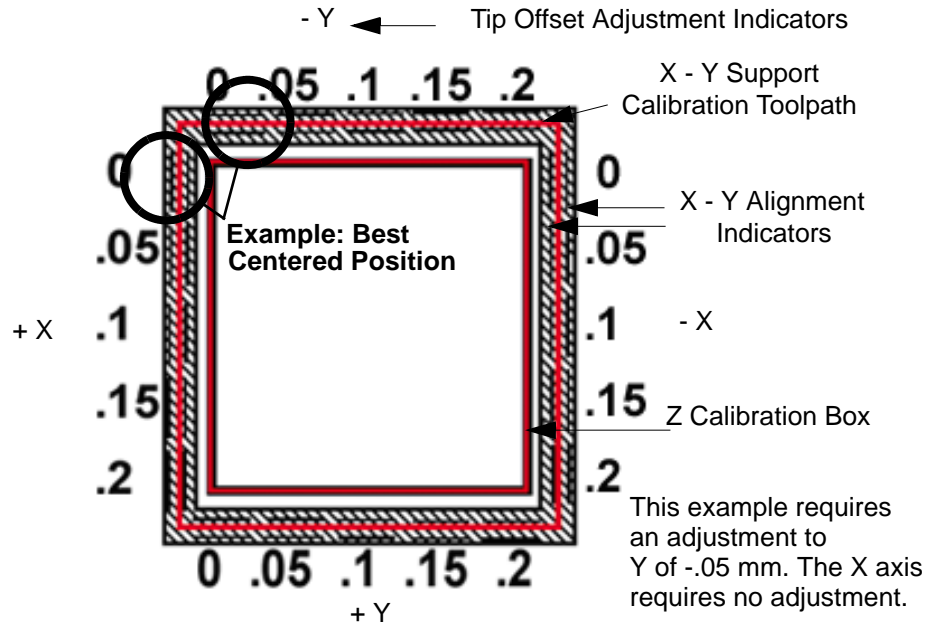

4. Determine the Z Adjustment.



Do not measure for Z adjustment until the Calibration Model shows the XY Offset to be less than 0.002 inch (0.05 mm) for the X and Y axis.

- Peel the Support layer from the Z Calibration box.
- Measure the thickness of the Support layer with a caliper or micrometer.
 - If the measured value is within ± 0.0005 inch (0.01 mm) of Model Tip slice height, no adjustment is necessary.
 - Enter the value that is read from the caliper in the "Support Thickness" field.
- If an adjustment entry is required, re-run the calibration model on a clean build sheet.
- Continue to check for Z Calibration until the Support layer matches the Model Tip slice height ± 0.0005 inch (0.01 mm).

AutoHome XYZ

When the AutoHome icon is pressed, the system will perform the following exercise with no operator interaction required:



AutoHome is used to move away from a limit switch.

1. Finds the Z home limit switch.
2. Finds the X home limit switch.
3. Finds the Y home limit switch.
4. Returns to the head parked position.



Chapter 6: System Maintenance



This chapter describes various maintenance items that the user will routinely have to perform on the Fortus 900mc system.

Updating Controller Software

The Controller software can be updated by using one of the two methods described below:

Web Method (preferred method)

This method is for customers who have web access.

1. Open the Control Center application and select the **Services** tab and then click **Check for System Updates**.

Figure 6-1: Control Center

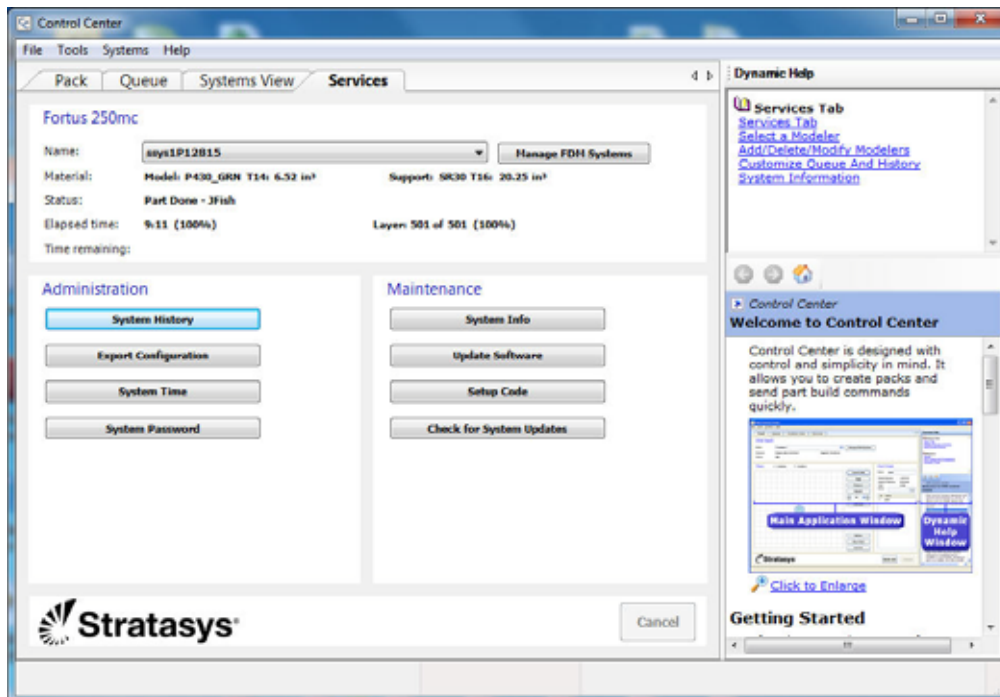

2. The Stratasy Update Manager window will appear. The application will check to see if the Controller software is current. Follow screen prompts to update the Controller software.

CD Method (alternate method)

This method is for customers who do not have web access. The Controller Software Update CD containing the updated .upg file and must be obtained from Stratasys, Inc.

1. Insert the Controller Software Update CD into the workstation computer and then transfer the .upg file to a known location on the workstation hard drive.
2. Make sure the system is placed in the receive software upgrade mode. (See “Placing System in Receive Software Upgrade Mode” on page 6-3.)
3. Open the Control Center application and select the **Services** tab and then click **Update Software**. (See Figure 6-1 on page 6-1.)
4. Browse to the location of the .upg upgrade file.
5. Select the .upg file to be downloaded and then press **Open**. This will send the file to the Fortus 900mc.
6. When the download is complete, select **Reboot and Install Software Upgrade** and then press **OK** at the Fortus 900mc system.

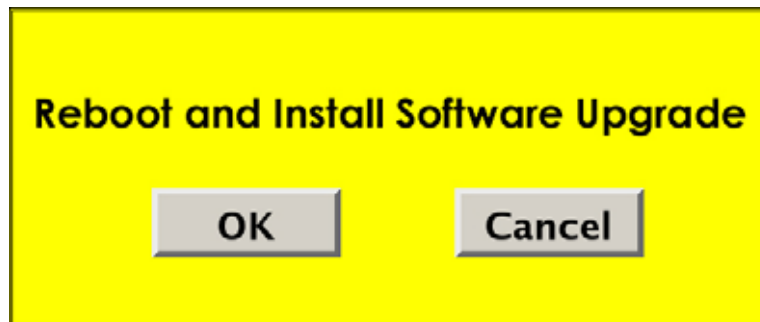

7. After the system reboots and the upgrade installation completes, the following screen appears:

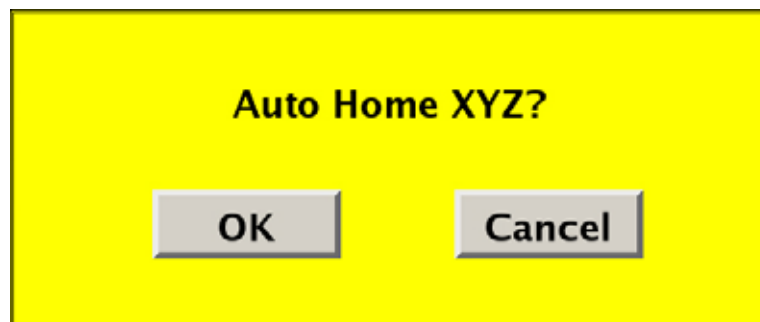

8. Press **OK** to complete the Auto Home XYZ calibration.

Placing System in Receive Software Upgrade Mode

Place the system in software upgrade mode by doing the following:

1. Navigate to the Administrator screen and then press the **Receive Software Upgrade** button. This will allow the system to accept the software upgrade.



Receive Software Upgrade



Upgrade in Process

Reinstalling Controller Software (Using USB Flash Drive)

The controller software can be reinstalled using a USB flash drive supplied by Stratatsys. All systems ship with a USB flash drive containing the controller software which was current at the time of system manufacture. As such, it is important that controller software be updated as appropriate following software reinstallation using the USB flash drive.

1. Unload materials and remove the canisters from the system.
2. If the Dynamic IP address is set to OFF, record the specific network parameters (IP Address, Network Mask and Gateway) found on the Administration screen of the system's touchscreen display. However, if the network configuration for Dynamic IP is set to ON, a network server or PC will automatically generate an IP address for the system and no action is required by the user.
3. Power OFF the system and allow the UPS to complete its delayed power down cycle.
4. Insert the USB flash drive into a USB port of the system's controller.
5. Press the green start button to power the system ON. (The green button will start to flash on and off at a slower rate.)
6. The computer will boot from the USB flash drive and the following message will appear:

This will erase all data on the drive.
Are you sure you want to continue?

Press **OK** to download the software or **Cancel** to abandon the operation.

7. Press **OK** on the touchscreen. The software transfer process will begin.



During the software transfer and subsequent automatic boot processes, various scripts will be seen on the touchscreen display.

DO NOT shutoff the system during the software downloading process.

DO NOT press any screen access buttons unless instructed to do so (i.e., the Release Notes button is non-functional at this release).

8. When installation is complete, the screen will display the following message:

Installation complete.
Remove installation media.

Remove the USB flash drive from the computer port before pressing **OK** to exit.

- The following screen will appear after the system reboots. Press **OK** to Auto Home XYZ the system using the downloaded software.



- Check for Controller software updates using the Control Center application. (See "Web Method (preferred method)" on page 6-1.)

Maintenance Schedule

Maintenance tasks must be performed on a regular basis in order to maintain optimal system operation. Table 1 outlines the general maintenance schedule. Detailed instructions for each task make up the rest of this chapter.



Warning: always wear proper heat protective clothing when working inside the oven.

Table 1: Maintenance Schedule

Daily	Weekly	Quarterly	Maintenance Task
X			"Clean the Platen" on page 6-6
X			"Empty the Purge Bucket" on page 6-7
	X		"Vacuum the Build Envelope" on page 6-8
	X		"Clean/Inspect Tip Wipe Assembly" on page 6-8
		X	"Clean the Tip Sensor Plunger" on page 6-10

Daily Maintenance

Clean the Platen

The platen is the surface on which the build sheet is placed for modeling. If debris collects on the platen, it can adversely affect the vacuum which secures the build sheet to the platen.

1. Remove the build sheet from the platen.
 - Lift a corner of the build sheet to break the vacuum holding it to the platen or turn off vacuum using the button on the touch screen.
 - Slide the build sheet from the platen.
2. Carefully remove debris that has fallen into the channels of the platen. Use a vacuum or use a soft brush.
 - If a brush is used, brush away from the vacuum port in the center of the platen.
 - If debris falls into the vacuum ports, it can cause a loss of vacuum, resulting in poor adhesion of the build sheet to the platen during part build.



Do not attempt to remove the vacuum port screens. They are not a customer replaceable items.

Figure 6-2: Platen Cleaning

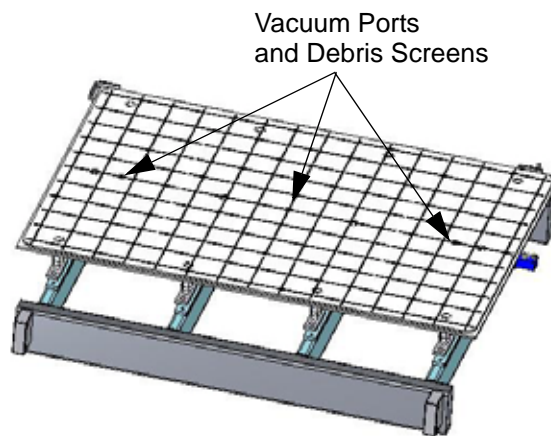

Empty the Purge Bucket

The purge bucket is located inside the oven. It catches the material that has been purged or wiped from the liquefiers and liquefier tips. The purge bucket should be emptied daily. (Figure 6-3)

 **Warning:** Always wear safety gloves and long sleeves when working inside the oven. Components are hot!

1. Open the Oven door. Use caution because the oven is hot.
2. Make sure the build platen is at the bottom of the envelope area.
3. Lift the purge bucket straight up from the purge bucket bracket and remove from the oven bay.
4. Empty the waste material from the purge bucket. There is a waste door at the bottom of the bucket.
5. Install the purge bucket on the purge bucket bracket.

Figure 6-3: Purge Bucket

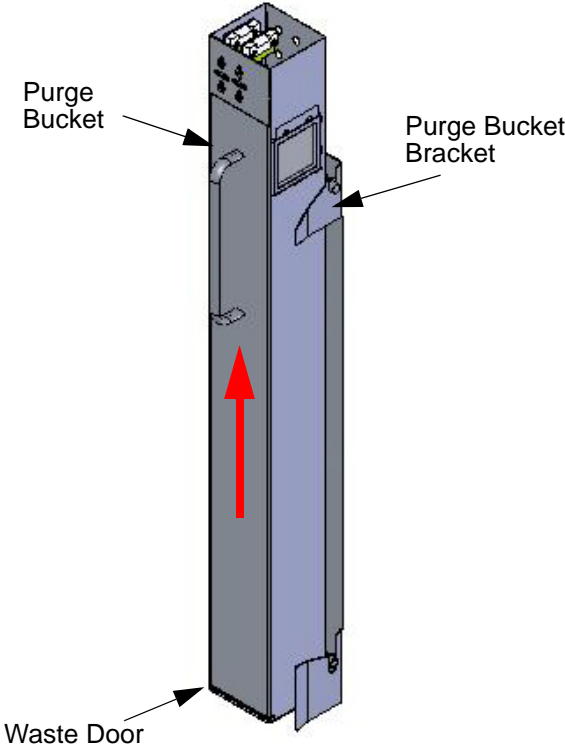

Weekly Maintenance

Vacuum the Build Envelope

Vacuum the build envelope to remove build material waste, debris, and dust.

Clean/Inspect Tip Wipe Assembly

Inspect the Tip Wipe Assembly once a week. Replace parts as necessary when wear is detected. See “[Consumable Orders](#)” on page 1-2 for more information. The brush and flicker are replaced as an assembly.

1. Remove the Tip Wipe Assembly by lifting straight up. (See [Figure 6-4](#)).

Figure 6-4: Chute Cleaning

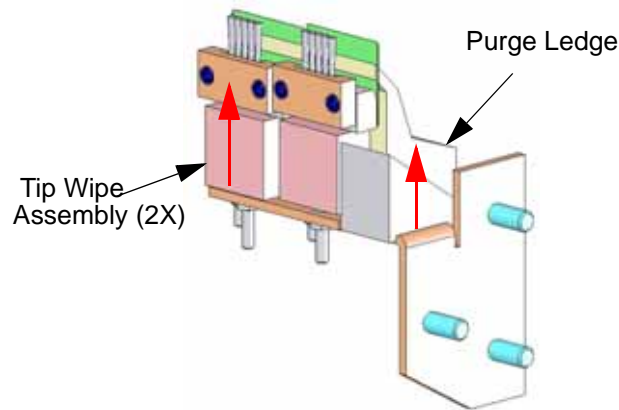

2. Remove the Purge Ledge assembly by lifting it straight up.
3. Use a cleaning brush (in the system start-up kit) to remove debris from around the Tip Wipe and Purge Ledge area.
4. Clean and inspect the surface around the locating pins - make sure that the Tip Wipe Assemblies and Purge Ledge can sit flush on the surface.
5. Inspect the Kapton tape around the upper funnel chute. Replace the Kapton tape if wear or tears are evident.
 - The Kapton tape is secured to the upper funnel chute with self-adhesive material. To replace the tape, peel the tape from the chute.
 - Clean the area around the top of the upper funnel chute with Isopropyl alcohol and a clean, lint-free cloth.
 - Peel the backing material from the new Kapton tape and carefully position the shield in place on the upper funnel chute - the top edge of the adhesive area should be even with the top of the chute.
 - Press the Kapton tape in place to secure.

6. Inspect the Purge Ledge assembly (Figure 6-5):
 - The purge surface should be free from pock marks or surface irregularities.
 - Install a new purge ledge assembly if necessary. Use a PPSF purge ledge assembly when using PPSF material.

Figure 6-5: Purge Ledge Assemblies

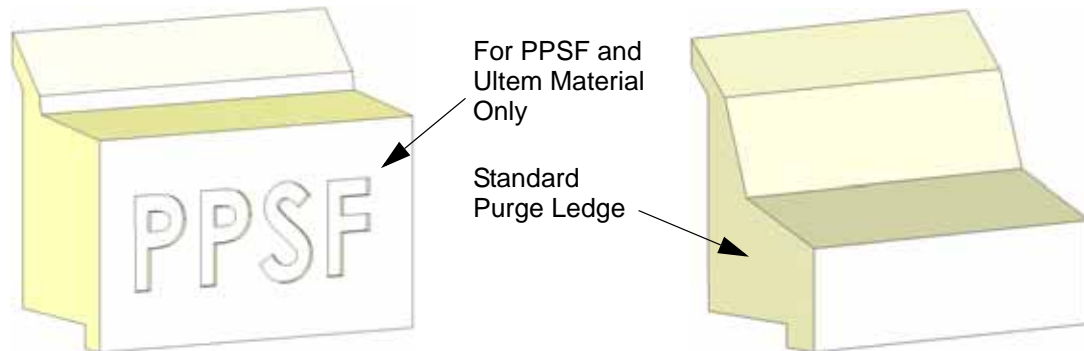

7. Inspect the flicker/brush assemblies.
8. The top edge of the flicker should be straight. Replace the flicker if it is notched or bent - a small amount of wear is acceptable (Figure 6-6). The flicker can be replaced individually if the brush is acceptable for reuse.

Figure 6-6: Inspecting the Flickers

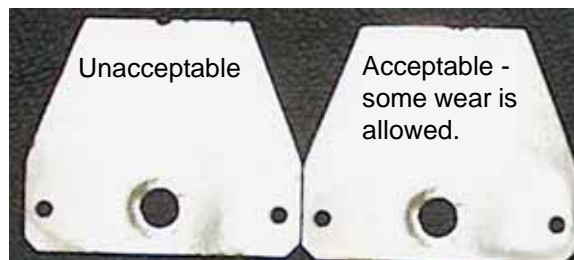

- The brush bristles must not show evidence of wear from the tip - no notches in the bristle pattern.
- Frayed bristles are acceptable as long as the top edge is even across all of the bristles.
- Replace the flicker/brush assembly if the brush does not meet inspection requirements.

9. Install the flicker/brush assemblies by placing them over the locating pins.
10. Install the purge ledge assembly by placing it over the locating pins.

Figure 6-7: Tip Wipe Assembly

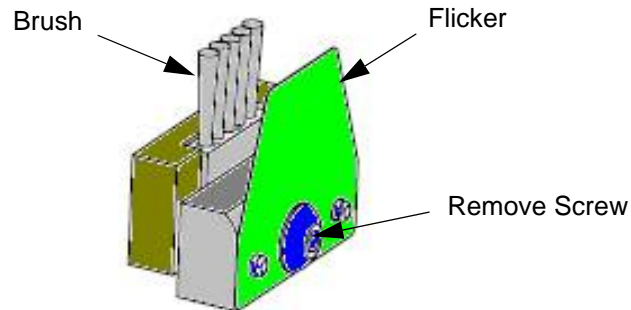

Quarterly Maintenance

Clean the Tip Sensor Plunger

1. Remove the plunger - gently pull up and out (Figure 6-8).
2. Remove material residue on the top of the plunger with a razor blade.
3. Replace the plunger in the sensor bracket making sure the flat surface is up.

Figure 6-8: Tip Sensor

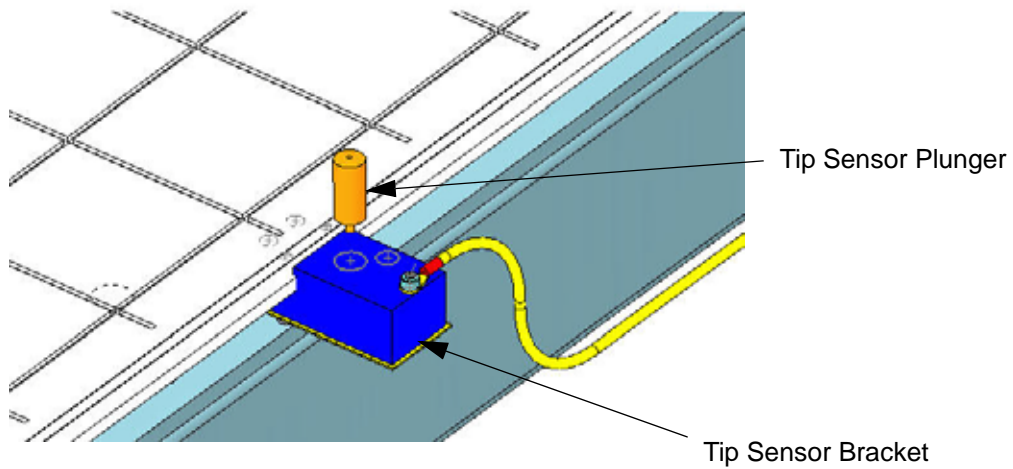

As Needed Maintenance

Clean The Liquefier Tips

The system automatically cleans the tips before and during each part build - using the tip cleaning assembly. However, occasionally, material may build up on the tips that cannot be removed during the auto-cleaning process. Remove excess material manually using a brass, wooden-handled brush (included in the Startup Kit).

Replace an Oven Lamp

The Oven Lamps, located inside the oven, will periodically burn out and require replacement. Use the following steps to replace a lamp:



Warning: Power down the system in the manner described below.



Caution: DO NOT continue until the six-minute cooling cycle has completed.

1. Power down the system and allow the oven to cool.
 2. Rotate the Power In Disconnect switch to the OFF position.
-



Warning: Always wear safety gloves and long sleeves when removing an oven lamp or working inside the oven. Components are hot!

3. Remove the burned out lamp and install the replacement lamp.
4. Rotate the Power In Disconnect switch to the ON position.
5. Power up the system and verify the lamps are operating.

Cleaning the Cabinet

Use a soft cloth moistened with mild soap and water to wipe down the outside of the cabinet. Do not use abrasive or high alkaline cleaners on the system. Vacuum all air vents of dirt and debris that would block airflow through the system.

Cleaning Plastic Components

Clean the oven door and all plastic components on the outside of the system using mild soap and water. Commercially available products made for cleaning plastic are also acceptable. Do not use abrasive or high alkaline cleaners on the system. Avoid streaks by rinsing with clear water and then drying with a soft cloth.



Chapter 7: Troubleshooting

7

This chapter describes basic troubleshooting that can be done by the user to correct basic problems with the Fortus 900mc system.

Getting Help

If you have problems with your system or materials, that are not covered in this User Guide or in the Quick Reference Card, or if you need to order replacement parts, please contact Customer Support by using one of the following methods:

In the USA

- Write to:
Stratasys, Inc.
Customer Support
7665 Commerce Way
Eden Prairie, MN 55344-2080
USA
- Phone: 800.801.6491 (7:00 AM to 5:00 PM C.T.)
- Email: support@stratasys.com

In Europe

Please contact your local distributor. For information on your local distributor please contact our European head quarters:

- Write to:
Stratasys GmbH
Weismuellerstr. 27
60314 Frankfurt/Main
Germany
- Phone: +49 (69) 420 994 30
- Fax: +49 (69) 420 994 333
- E-mail: europe@stratasys.com

- Before calling for service or supplies, always have the following information ready:
- Your system’s software version.
- Your system’s serial number.
- Access to your Insight workstation (to provide a diagnostic file if necessary).

Finding a Remedy

Condition	Possible Cause	Remedy
Canister will not load	Anti-rotation plug not removed from canister.	Remove plug.
	Rubber thumbwheel insert not removed from thumbwheel door.	Remove thumbwheel insert.
	Empty canister (zero volume).	Replace canister.
	Filament stuck in canister.	Remove canister from system and pull out about eight feet (two meters) of material out. Ensure filament pulls out freely.
	Canister drive block not fully lowered onto canister.	Reset drive block onto canister.
	Wrong tip size selected on operator display.	Verify correct tip size on display. See “Liquefier Tips and Slice Heights” on page 2-11.
	Canister smartspool circuit failed.	View Filament Status from operator display. If the status reads None or is blank, replace the canister.
	Broken or bent pogo pin.	Remove canister from bay and check pogo pins on underside of the canister drive block. Replace any bent or broken pogo pins.
Filament does not reach head (load time-out reached).	Install a new canister. If this fails, call Customer Support.	

Condition	Possible Cause	Remedy	
Loss of extrusion (Head will not extrude material).	Filament stuck in canister.	Remove canister from system and pull out about 8 feet (2 meters) of material out. Ensure filament pulls out freely.	
	Canister drive is too slow.	Verify that load time from the canister to the head switch is less than 2 min.	
	Material not extruding on first two layers of model base.	Verify that material purges by performing a load.	
	Plugged tips.		Verify that the size of installed tip matches with tip size indicated on operator display.
			Verify that tip life has not exceeded maximum odometer.
			Verify tips were installed correctly. Verify that material purges by performing a load.
		Replace tip with new tip and the calibrate.	
System not calibrated.	Verify that material purges by performing a load. Perform Auto Z Stage Zero and AutoCal Tips.		
Low vacuum caused build sheet to shift and may have plugged tip.	See Low Vacuum in this table.		
Low Vacuum.	The build sheet is not properly installed.	Move the sheet until it overlaps the platen equally on all sides.	
	There is filament debris on the platen.	Remove the build sheet and clean the top surface of the platen.	
	A small piece of material may have been sucked into the vacuum line.	Empty the vacuum system filter jars.	
	The vacuum screen may be plugged.	Clean the vacuum screen. Do NOT remove the screen - it is not a customer replaceable item.	
Air Pressure Low.	This scenario is not operator adjustable.	Contact Customer Support for further instructions.	

Condition	Possible Cause	Remedy
Support Material is difficult to remove from part.	Support material is embedded in the vertical surfaces of the part.	Adjust the tip-to-tip calibration.
Model material surface finish is poor on downward facing surfaces. Support material removes too easily.	The tip-to-tip calibration is not set correctly.	Repeat tip-to-tip calibration.
Material is oozing.	Dryer failure.	Call Customer Support.
	Moisture in the canister.	Call Customer Support.
	Air pressure low.	
Oven not maintaining temperatures.	Heater failure.	Call Customer Support.
	Oven door open.	Close the oven door; the heater turns off while the door is open.
	Oven door not sealing with oven fascia panel.	Call Customer Support.

Information Available If a Job Fails While Building:

If a job fails, you can determine the last layer built by selecting the "previous job" from the Operator Touchscreen.

